

## Product Catalogue

Our device portfolio for you at a glance



## Content

<b>Filter monitoring</b> .....	<b>4</b>
Filter monitoring devices by comparison .....	5
Filter monitoring device PFM 13.....	6
Filter monitoring device PFM 13 C.....	8
Filter monitoring device PFM 13 C EX.....	10
Filter monitoring device PFM 20 F.....	12
<b>Dust measurement</b> .....	<b>14</b>
Dust measuring devices by comparison.....	15
Dust measuring device PFM 20 .....	16
Dust concentration measuring device OPM 19 ED .....	18
<b>Ambient air monitoring</b> .....	<b>20</b>
Ambient air monitoring devices by comparison.....	21
Fine dust sensor FDS 15.....	22
Fine dust sensor FDS 17.....	24
<b>Hot-wet gas analysis</b> .....	<b>26</b>
Application examples for hot-wet gas analyser systems.....	27
Hot-wet gas analysers for stationary applications by comparison.....	28
Portable hot-wet gas analysers for temporary monitoring by comparison.....	29
Multi component analyser MCA 10 HWIR .....	30
Hot gas UV analyser UVA 17 HW.....	32
Flame Ionisation Detector FID 22 TOC .....	34
Flame Ionisation Detector FID 22 NMHC .....	36
Multi component analyser system MCA 10 maritime.....	38
Mobile multi component analyser MCA 14 m .....	40
Flame Ionisation Detector FID 22 m TOC .....	42
Flame Ionisation Detector FID 22 m NMHC.....	44
<b>Cold-dry gas analysis</b> .....	<b>46</b>
Cold-dry gas analysers by comparison .....	47
Multi gas analyser MGA 12.....	48
Multi gas analyser MGA 12 EX.....	50
Cold gas UV analyser UVA 17 CD.....	52
Multi gas analyser MGA 20.....	54

<b>Oxygen measurement</b> .....	<b>56</b>
Oxygen measuring devices by comparison.....	57
Oxygen measuring device OMD 14.....	58
Multi gas analyser MGA 12 for O <sub>2</sub> measurement .....	60
Multi gas analyser MGA 12 EX for O <sub>2</sub> measurement.....	62
Multi gas analyser MGA 20.....	64
<b>Flow measurement</b> .....	<b>66</b>
Flow measuring devices by comparison.....	67
Flow measuring device FMD 02 .....	68
Flow measuring device FMD 09 .....	70
<b>System accessories</b> .....	<b>72</b>
Monitoring and control in gas analysis systems .....	73
Heated sample probe HSP 12.....	74
Measuring gas pump MGP 12.....	76
Peltier gas cooling unit GCU 16 .....	78
Display Unit DUx 20 .....	80

# Filter monitoring



A qualitative dust measurement, for example by tribo-electric filter monitoring, includes both the monitoring of the clean gas after dust collectors as well as the evaluation of the status of the exhaust gas cleaning systems.

The signal generation is based on the tribo electric measuring principle. The charge exchange between the probe and the streaming as well as the bouncing dust particles is carried out.

According to the triboelectric measuring principle, the filter monitoring device is installed as in-situ measuring device in the clean gas pipes after the dust collectors. These devices are suitable for monitoring baghouse-, envelope- and cartridge filters and centrifugal separators (cyclones).

The evaluation of the filter controllers' signals therefore allows an identification of incipient wear of filter material

at a very early stage, which means that emissions of these bag rows had not been visible or

had hardly been visible so far. So, the operator receives the warning about a deteriorating filter state in good time, long before a dust plume can be seen or noticed by authorities and neighbours. Therefore, extraordinary dust emissions and filter leakage can be avoided.

There are more than 15,000 pcs of Dr. Födisch Umweltmesstechnik AG filter monitor devices operating worldwide e.g.:

- cement industry
- metal-working industry (e.g. foundries, blasting plants)
- food processing industry
- woodworking industry
- chemical and pharmaceutical industry

## Monitoring at a dust collector with zero-defect filter bags

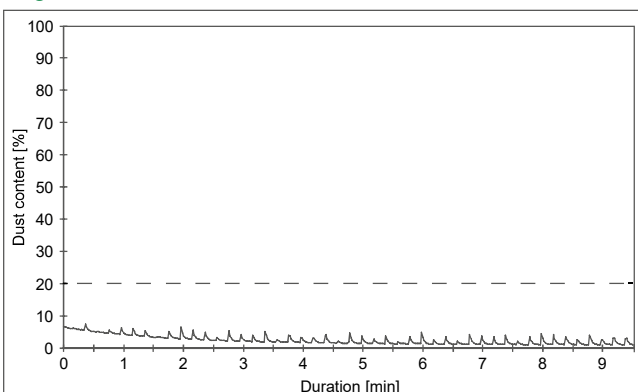

## Monitoring at a dust collector with defective filter bags

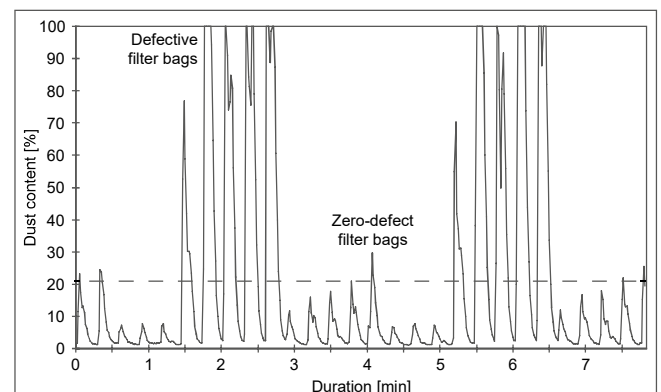

## Filter monitoring devices by comparison

	PFM 13	PFM 13 C	PFM 13 C EX	PFM 20 F
<b>Field of application</b>				
Continuous monitoring of filters (except electrostatic precipitators)	●	●	●	●
Monitoring of exhaust gases in wood-processing industry				●
TÜV approved acc. to DIN EN 15267-1 (2009), DIN-EN 15267-2 (2009), DIN EN 15859 (2010), DIN EN 14181 (2015)				●
Application in potentially explosive atmospheres (ATEX)			●	
Exhaust conditions:				
• Dry gases	●	●	●	●
• Occasional dew point shortfalls				
• Media temperature up to 280 °C	●	●	●	●
• Media temperature up to 450 °C				
Mobile use				
<b>Device characteristics</b>				
Measuring principle:				
• Tribo-electric	●	●	●	●
Measuring arrangement:				
• In-situ	●	●	●	●
• Extractive				
Process connection:				
• Sleeve	● <sup>[2]</sup>	● <sup>[2]</sup>	● <sup>[2]</sup>	
• Tri-Clamp	●	●	●	●
• Flange				
Data transfer:				
• Analogue outputs 4...20 mA	●	●	●	●
• Digital outputs (e.g. limit value 1/2, maintenance request, maintenance, failure)	●	●	●	●
• RS 485 / Modbus RTU				●
Other device features:				
• Compact device with integrated electronics	●	●	●	●
• Integrated display/operating unit	●			
• Detached display/operating unit				
• Variable length of probe rod	● <sup>[3]</sup>	● <sup>[3]</sup>	● <sup>[3]</sup>	● <sup>[3]</sup>
• Isolated piping	● <sup>[4]</sup>	● <sup>[4]</sup>	● <sup>[4]</sup>	● <sup>[4]</sup>
<b>Measuring components</b>				
Dust	●	●	●	●
<sup>[1]</sup> as special model PFM 02 T <sup>[2]</sup> customisation via adapter <sup>[3]</sup> probe rod length 300 mm or 500 mm (= immersion depth 410 mm resp. 610 mm) <sup>[4]</sup> isolation up to 100 mm (max.), PFM 20 F optional with isolator of about 250 mm				

### Filter monitoring device PFM 13

Continuous, tribo-electric in-situ measurement for qualitative monitoring of exhaust gas



#### APPLICATION

The PFM 13 serves the permanent control of dust emissions. Applied as a filter monitoring device it is an effective implement to detect and localise damages to filtering precipitators at an early stage. Configured as a dust measuring device it can be used for continuous monitoring of clean gas contents and dust contents of filtering precipitators.

#### INSTALLATION EXAMPLE



#### YOUR BENEFITS AT A GLANCE

- local diagnosis of system state by integrated graphic display
- no separate power supply necessary (2-wire transmitter)
- dust measurement and filter monitoring with one compact device
- no purge air blower required
- low operational costs
- easy mounting

#### PRECONDITIONS ON SITE

- ambient temperature: -20...+50 °C
- location free of percussion
- homogenous dust and stack gas distribution
- flow velocity of min. 3 m/s
- installation place with run-in/run-out zone of min. 5-fold/2-fold length of duct diameter
- power supply for 2-wire transmitter
- processing of measuring signals

## PROCESS CONNECTION BY TRI-CLAMP

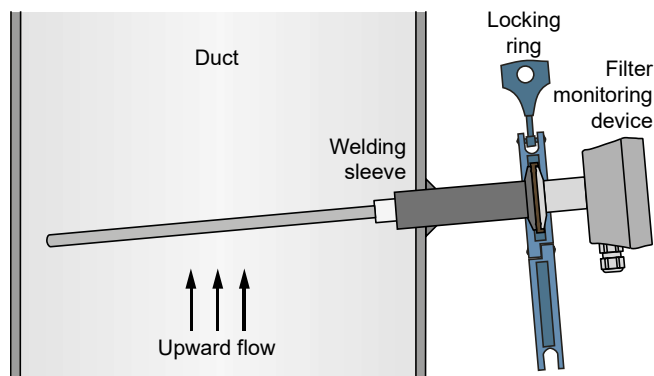

## DIMENSIONS



## TECHNICAL DATA

Housing:	compact device (integrated graphic display with operating); IP65
Dimensions:	approx. 100 mm x 120 mm x 530/730 mm (w x h x d)
Weight:	approx. 1.0 kg
Probe:	tribo-electric probe consisting of device, probe isolator and probe rod; probe rod: electrically isolated from housing, length: 300/500 mm (possible to shorten mechanically); immersion depth: approx. 410/610 mm (dependent on application)
Display / Operating:	graphic display with touch function at probe head; switches at signal module
Ambient temperature:	-20...+50 °C
Relative humidity:	no special sensitivity
Dew-point spread:	min. +5 K
Measuring gas temperature:	max. 280 °C
Flow velocity:	min. 3 m/s
Measuring range of dust:	0...100% (qualitative)
Gain levels:	4
Operational availability:	immediately after switch-on of power supply
Calibration:	by gravimetric comparison measurements (for trend measurement and filter analysis not required)
Analogue output:	4...20 mA, 2-wire transmitter, galvanically isolated to device ground, burden max. 150 Ω
Digital outputs:	limit value 1 and 2 freely adjustable via menu (solid-state relays, standard: not activated); load capacity: max. 60 Vp, max. 75 mA; forward resistance: max. 10 Ω
Process connection:	welding sleeve with Tri-Clamp fastener
Cable gland / tightening zone:	M20 x 1.5 / 9...13 mm
Power supply:	2-wire transmitter (4...20 mA); min. 15 V DC / max. 30 V DC
<i>Special models are possible on request.</i>	



### Filter monitoring device PFM 13 C

Continuous, tribo-electric in-situ measurement for qualitative monitoring of exhaust gas



#### APPLICATION

The PFM 13 C serves the permanent control of dust emissions. Applied as a filter monitoring device it is an effective implement to detect and localise damages to filtering precipitators at an early stage. Configured as a dust measuring device it can be used for continuous monitoring of clean gas contents and dust contents of filtering precipitators.

#### INSTALLATION EXAMPLE

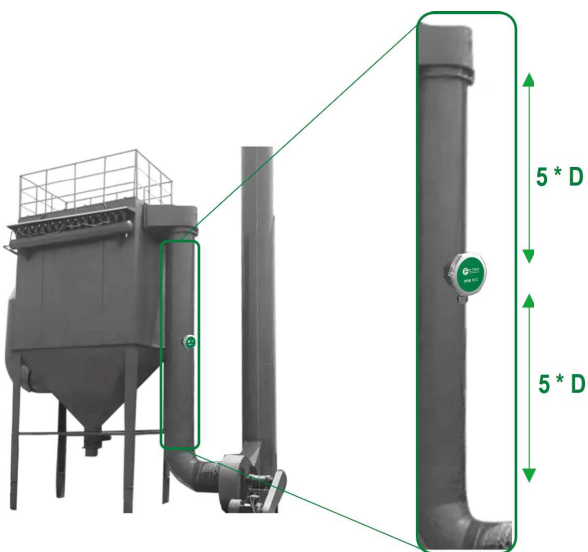

PFM 13 C on the clean air side of a filter and in a pipe

#### YOUR BENEFITS AT A GLANCE

- dust measurement and filter monitoring with one compact device
- no separate power supply necessary (2-wire transmitter)
- no purge air blower required
- low operational costs
- easy mounting

#### PRECONDITIONS ON SITE

- ambient temperature: -20...+50 °C
- location free of percussion
- homogenous dust and stack gas distribution
- flow velocity of min. 3 m/s
- installation place with run-in/run-out zone of min. 5-fold/2-fold length of duct diameter
- power supply for 2-wire transmitter
- processing of measuring signals



PROCESS CONNECTION BY TRI-CLAMP

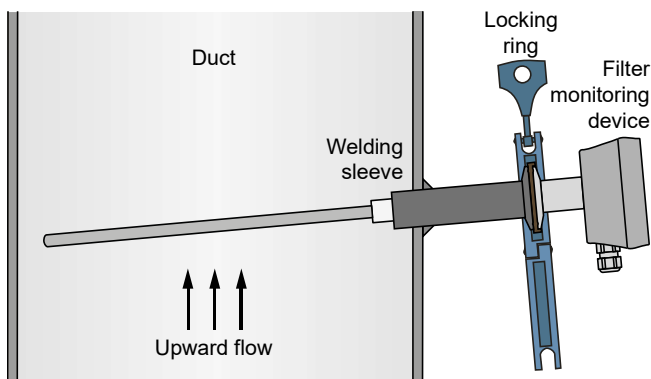

DIMENSIONS



TECHNICAL DATA

Housing:	compact device; IP65
Dimensions:	approx. 100 mm x 120 mm x 530/730 mm (w x h x d)
Weight:	approx. 0.9 kg
Probe:	tribo-electric probe consisting of device, probe isolator and probe rod; probe rod: electrically isolated from housing, length: 300/500 mm (possible to shorten mechanically); immersion depth: approx. 410/610 mm (dependent on application)
Operating:	switches at signal module
Ambient temperature:	-20...+50 °C
Relative humidity:	no special sensitivity
Dew-point spread:	min. +5 K
Measuring gas temperature:	max. 280 °C
Flow velocity:	min. 3 m/s
Measuring range of dust:	0...100% (qualitative)
Gain levels:	4
Operational availability:	immediately after switch-on of power supply
Calibration:	by gravimetric comparison measurements (for trend measurement and filter analysis not required)
Analogue output:	4...20 mA, 2-wire transmitter, galvanically isolated to device ground, burden max. 480 Ω
Process connection:	welding sleeve with Tri-Clamp fastener
Cable gland / tightening zone:	M20 x 1.5 / 9...13 mm
Power supply:	2-wire transmitter (4...20 mA); min. 15 V DC / max. 30 V DC
<i>Special models are possible on request.</i>	

### Filter monitoring device PFM 13 C EX

Highly sensitive system for continuous, tribo-electric in-situ measurement in potentially explosive atmospheres



- EC-type examination certificate according to EN 60079, ATEX directive (IBExU19ATEXB008X)
- approved for Ex II 3D Ex ic tc IIIC T80°C Dc X
- application in Ex-Zone 22



#### APPLICATION

The PFM 13 C EX serves the permanent control of dust emissions. Applied as filter monitoring device it is an effective implement to detect and localise damages at filtering precipitators at early stage. Configured as dust measuring device it can be used for continuous monitoring of clean gas contents and dust contents of filtering precipitators.

The filter monitor can be used in potentially explosive areas (Zone 22, dust).

#### INSTALLATION EXAMPLE

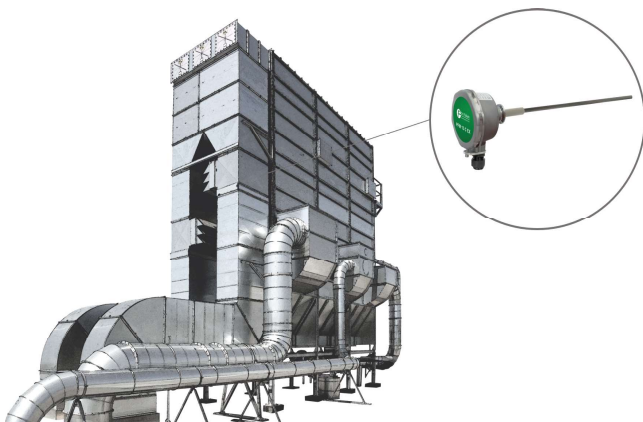

#### YOUR BENEFITS AT A GLANCE

- certified for application in Ex-Zone 22
- dust measurement and filter monitoring with one compact device
- no separate power supply necessary (2-wire transmitter)
- no purge air blower required
- low operational costs
- easy mounting

#### PRECONDITIONS ON SITE

- ambient temperature: -20...+50 °C
- location free of percussion
- homogenous dust and stack gas distribution
- flow velocity of min. 3 m/s
- installation place with run-in/run-out zone of min. 5-fold/2-fold length of duct diameter
- power supply for 2-wire transmitter
- processing of measuring signals

#### USE IN POTENTIALLY EXPLOSIVE AREAS

- filter monitor is suitable for use in Ex-Zone 22
- explosion-proof housing

PROCESS CONNECTION BY TRI-CLAMP

DIMENSIONS

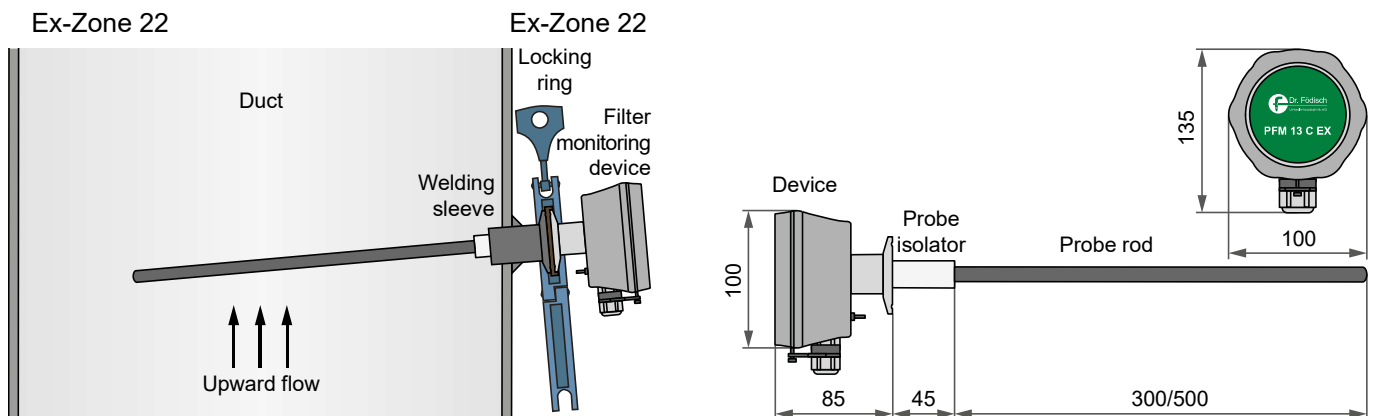

TECHNICAL DATA

ATEX certification:	Ex II 3D Ex ic tc IIIC T80°C Dc X
Housing:	compact device; IP 65
Dimensions:	approx. 100 mm x 135 mm x 430/630 mm (w x h x d)
Weight:	approx. 1.4 kg
Probe:	tribo-electric probe consisting of device, probe isolator and probe rod; probe rod: electrically isolated from housing, length: 300/500 mm (possible to shorten mechanically); immersion depth: approx. 310/510 mm (dependent on application)
Operating:	switches at signal module
Ambient temperature:	-20...+50 °C
Relative humidity:	no special sensitivity
Dew-point spread:	min. +5 K
Measuring gas temperature:	max. 260 °C
Flow velocity:	min. 3 m/s
Measuring range of dust:	0...100% (qualitative)
Gain levels:	4
Operational availability:	immediately after switch-on of power supply
Calibration:	by gravimetric comparison measurements (for trend measurement and filter analysis not required)
Analogue output:	4...20 mA, 2-wire transmitter, galvanically isolated to device ground, burden max. 480 Ω
Process connection:	welding sleeve with Tri-Clamp fastener
Cable gland / tightening zone:	M20 x 1.5 / 9...13 mm
Power supply:	2-wire transmitter (4...20 mA); min. 15 V DC / max. 30 V DC
<i>Special models are possible on request.</i>	

### Filter monitoring device PFM 20 F

Continuous, tribo-electric in-situ measurement for qualitative monitoring of exhaust gas



- suitability test according to DIN EN 15267-1 (2009), DIN-EN 15267-2 (2009), DIN EN 15859 (2010), DIN EN 14181 (2015)
- QAL1 certified

#### APPLICATION

The PFM 20 F serves the permanent control of dust emissions and is an effective implement to detect and localise damages to filtering precipitators at an early stage. By the device visible and invisible exhaust plumes can be avoided. The monitoring furthermore enables directed maintenance procedures and serves the avoidance of product losses.

#### INSTALLATION EXAMPLE

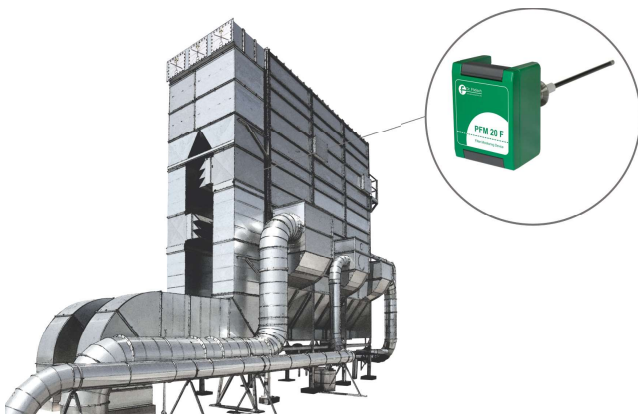

#### YOUR BENEFITS AT A GLANCE

- compact device with integrated operating elements
- variable application possibilities through probe rod modification
- different order configurations for power supply possible
- measuring value output in % respectively mA
- Modbus and PC interface
- connection for optional display/operating device
- easy mounting

#### PRECONDITIONS ON SITE

- ambient temperature: -20...+50 °C
- location free of percussion
- homogenous dust and stack gas distribution
- flow velocity of min. 5 m/s
- dew-point spread: min. +5 K
- installation place with run-in/run-out zone of min. 5-fold/2-fold length of duct diameter
- power supply
- processing of measuring signals

PROCESS CONNECTION BY TRI-CLAMP

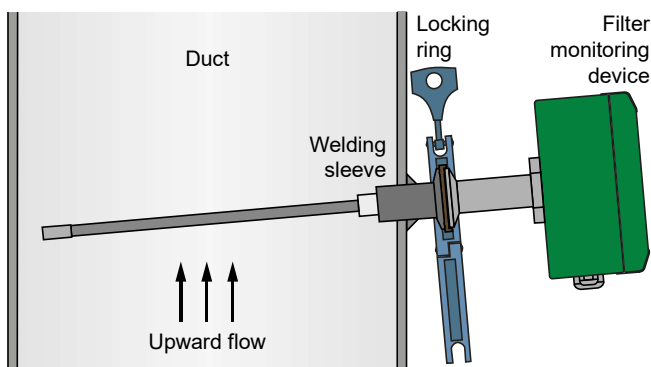

DIMENSIONS

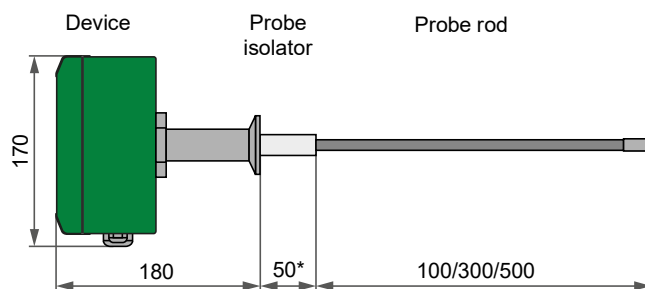

\* optional length of isolator: 250 mm

TECHNICAL DATA

Housing:	compact device with aluminium housing; IP 65
Probe:	tribo-electric probe consisting of device, probe isolator and probe rod; probe rod: high temperature coating, electrically isolated from housing (standard probe isolator: 50 mm), length: 100/300/500 mm; immersion depth: approx. 150/350/550 mm
Dimensions (standard):	approx. 130 mm x 170 mm x 330/530/730 mm (w x h x d)
Weight:	approx. 2.0 kg
Probe isolator:	standard 50 mm; optional 250 mm
Display / Operating:	LEDs and switches at signal module
Ambient temperature:	-20...+50 °C
Relative humidity:	no special sensitivity
Measuring gas:	temperature: max. 280 °C; dew-point spread: min. +5 K
Flow velocity:	min. 5 m/s
Measuring range of dust:	raw signal: 0...250 mV (approx. 0...250 mg/m <sup>3</sup> )
Operational availability:	approx. 1 min after switch-on of power supply
Calibration:	limit value determination possible by gravimetric measurement
Analogue output:	1 analogue output 4...20 mA for raw signal [mV], 2-wire transmitter, galvanically isolated to device ground, burden max. 500 Ω
Digital outputs:	4 potential-free contacts for failure, maintenance, limit value 1 and limit value 2 / optionally maintenance request; 24 V, 100 mA
Interfaces:	<ul style="list-style-type: none"> <li>• PC interface (USB, for parameter setting)</li> <li>• Modbus RS 485 according to directive VDI 4201 page 3</li> <li>• Modbus for optional display/operating device (DUx 20)</li> </ul>
Process connection:	welding sleeve with Tri-Clamp fastener
Cable gland / tightening zone:	<ul style="list-style-type: none"> <li>• 1 x M16 x 1.5;</li> <li>• 2 x M12 x 1.5</li> </ul>
Power supply:	<ul style="list-style-type: none"> <li>• 110...230 V AC, fuse 1 AT, 10 W; pre-fuse: min. 1.2 AT</li> <li>• 24 V DC (optional), 10 W; pre-fuse: min. 500 mA</li> </ul>
Optional:	<ul style="list-style-type: none"> <li>• display and operation unit (DUx 20)</li> <li>• WLAN module</li> </ul>
<i>Special models are possible on request.</i>	

# Dust measurement



Devices used for the continuous dust measurement register in the wider sense the physical changes caused by the particles in the measuring system, converting them into electrical signals. For that, the measured object can be analysed directly in exhaust gas channel (in-situ measurement) or a partial volume flow is collected and fed into a measuring device (extractive sampling).

As a result of the in-situ techniques, the measurement signals derive from the direct interaction of light or a tribo electric probe with the dust particles in the exhaust gas channel. For evaluation of the scattered light or the absorbance of a transmitted light beam respectively tribo electricity can be used.

The in-situ measuring devices are only suitable for the measurement of dust in dry gases. In the case of wet gases saturated with water vapor, the existing water droplets and aerosols also create effects, which distort the measurements results. Therefore, in these

cases the extractive measurement technique should be selected. The basis of the extractive methods constructs a preferably isokinetic partial flow extraction from the main gas flow.

The process-related restrictions have substantial influence over the choice of the measurement method.

Dust concentration measuring devices are mainly applied in:

- coal-fired power plants
- biomass power plants
- waste to energy plants
- incinerators

In addition, Dr. Födisch UMT AG offering devices for periodic dust concentration measurements. These are usually applied as a standard reference method for calibration of continuous dust concentration measuring devices (gravimetric calibration).

## Influences on tribo-electric dust measurement

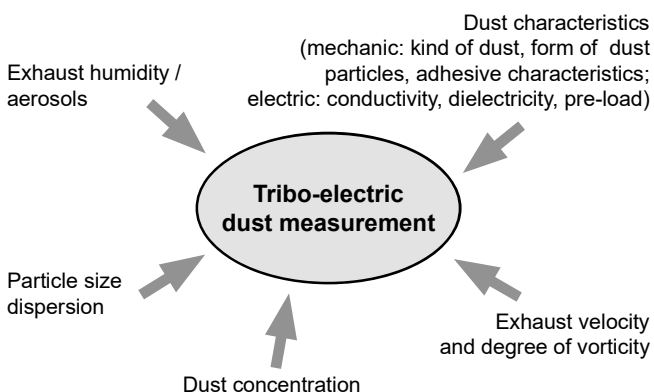

## Influences on optic dust measurement

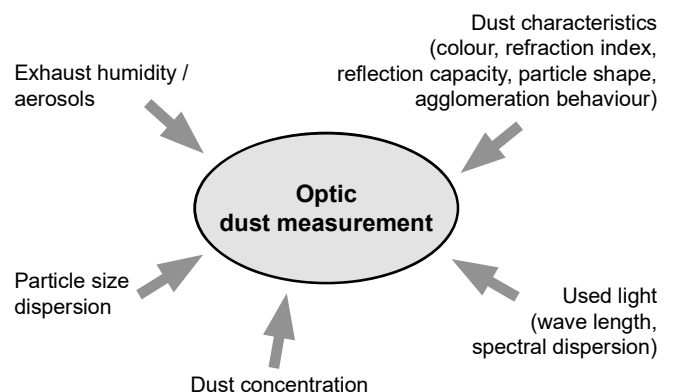

## Dust measuring devices by comparison

	PFM 20	OPM 19 ED
<b>Field of application</b>		
Continuous measurement of dust concentration	●	●
TUV-approved monitoring of dust emissions	● <sup>[1]</sup>	● <sup>[5]</sup>
Discontinuous, manual gravimetric determination of dust content (according to VDI 2066, page 1, 2, 3, 7) with mobile use		
Determination of dust content based on hot weighing		
Exhaust conditions:		
• Dry gases	●	
• Wet gases		●
<b>Device characteristics</b>		
Measuring principle:		
• Tribo-electric	●	
• Optic		●
Measuring arrangement:		
• In-situ	●	
• Extractive		●
Probe material:		
• 1.4571	●	●
• Hastelloy		●
Process connection:		
• Tri-Clamp	●	
• Flange		●
Data transfer:		
• Analogue outputs 4...20 mA	●	●
• Digital outputs (e.g. limit value 1/2, maintenance request, maintenance, failure)	●	●
• RS 485 / Modbus RTU	●	
Other device features:		
• Compact device with integrated electronics	●	●
• Detached display/operating unit		opt.
• Variable length of probe rod	● <sup>[2]</sup>	opt.
• Isolated piping	● <sup>[3]</sup>	●
<b>Measuring components</b>		
Dust concentration	●	●
Volume flow / velocity	● <sup>[4]</sup>	
Temperature	● <sup>[4]</sup>	
Pressure	● <sup>[4]</sup>	
<p><sup>[1]</sup> suitability tested according to EN 15267-3, certified in compliance with QAL1</p> <p><sup>[2]</sup> probe rod length 300 mm or 500 mm (= immersion depth 410 mm resp. 610 mm)</p> <p><sup>[3]</sup> isolator up to 100 mm (max.); PFM 20 optional isolator of about 250 mm</p> <p><sup>[4]</sup> in combination with flow measuring device FMD 02 / FMD 09</p> <p><sup>[5]</sup> certification in progress</p>		



### Dust measuring device PFM 20

Continuous, tribo-electric monitoring of dust concentration in exhaust gas

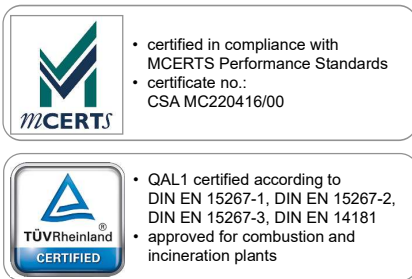

#### APPLICATION

The PFM 20 is a highly sensitive device for continuous measurement of dust emissions. The device meets highest international and European standards.

It is suitable for emission control on waste incineration plants and other combustion plants.

The plug-and-measure device is simple to maintain. The clamp connection allows a quick inserting as well as taking out of the probe which simplifies any kind of service activities like checks or cleaning.

The robust design makes it long lasting (operating time > 10 - 15 years).

#### INSTALLATION EXAMPLE

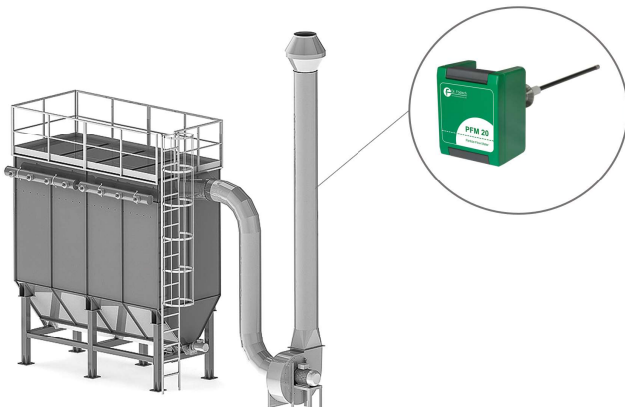

#### YOUR BENEFITS AT A GLANCE

- lowest certified range 0 - 7.5 mg/m<sup>3</sup> dust, max. measuring range 0...250 mg/m<sup>3</sup> dust (special range 0...1,000 mg/m<sup>3</sup> dust on request)
- automatic zero and reference point check
- compact probe head and coated probe rod
- robust device and long-term stable measurement results
- probe rod length of about 100, 300, or 500 mm
- different power supply options
- Modbus RS 485, analogue and digital signal output
- connectivity for external display and operation unit (DUx 20; optional)

#### PFM 20 DEVICE VERSIONS

- PFM 20 T - suitable for use in the high-temperature range of up to 1,000 °C
- PFM 20 C - with customizable probe length
- PFM 20 D - with customizable probe length and display

PROCESS CONNECTION BY TRI-CLAMP

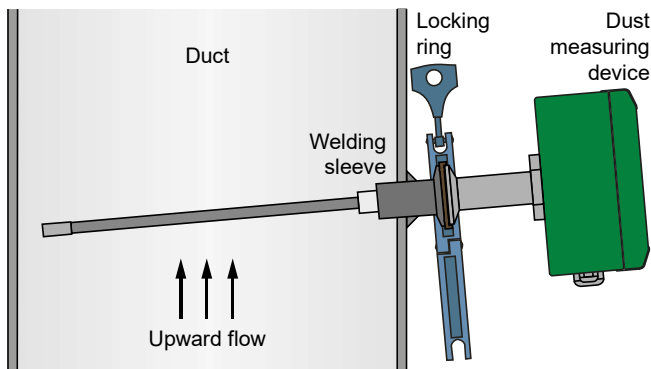

DIMENSIONS

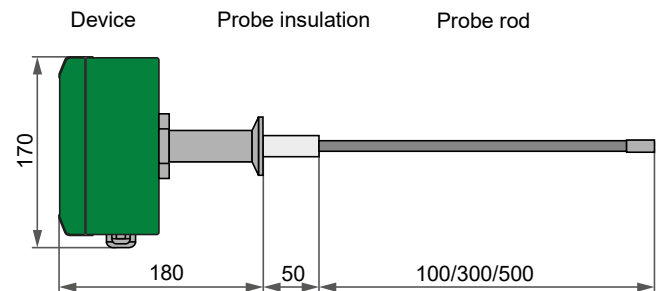

PRECONDITIONS ON SITE

- ambient temperature: -20...+50 °C
- flow velocity of min. 3 m/s
- dew-point spread: min. +5 K
- processing of measuring signals

TECHNICAL DATA

Housing:	compact device with aluminium housing; IP 65
Probe:	tribo-electric probe consisting of probe rod and probe head; coated probe rod, electrically isolated from housing, probe rod length: 100/300/500 mm
Dimensions; weight:	130 mm x 170 mm x 330/530/730 mm (w x h x d); 2.1 kg (300 mm)/2.25 kg (500 mm)
Operating conditions:	
Exhaust gas temperature:	max. 280 °C
Relative humidity (air):	no special sensitivity
Measuring range of dust:	raw signal: 0...250 mV; dust concentration: 0...250 mg/m <sup>3</sup> (0...1,000 mg/m <sup>3</sup> on request)
Operational availability:	approx. 1 min after switch-on of power supply
Calibration:	by gravimetric comparison measurements (not required for trend and filter analysis)
Analogue outputs:	2 x 4...20 mA, galvanically isolated to device ground, burden max. 500 Ω; outputs for: <ul style="list-style-type: none"> <li>• dust concentration C<sub>IB</sub> [mg/m<sup>3</sup>]</li> <li>• raw signal [mV]</li> </ul>
Analogue input:	1 x 4...20 mA for external velocity v [m/s], galvanically isolated to device ground
Digital outputs:	4 potential-free contacts for failure, maintenance, limit value 1 and limit value 2 / optionally maintenance request; 24 V, 100 mA
Interfaces:	<ul style="list-style-type: none"> <li>• USB interface to PC (for parameter setting)</li> <li>• Modbus RS 485 according to directive VDI 4201 page 3</li> <li>• Modbus for optional unit (DUx 20)</li> </ul>
Process connection:	welding sleeve with Tri-Clamp fastener
Cable gland / tightening zone:	<ul style="list-style-type: none"> <li>• 1x M16 x 1.5;</li> <li>• 2x M12 x 1.5</li> </ul>
Power supply:	<ul style="list-style-type: none"> <li>• 110...240 V AC, 50...60 Hz, fuse 1 AT, 10 W; pre-fuse: min. 1.2 AT</li> <li>• 24 V DC (optional), 10 W; pre-fuse: min. 500 mA</li> </ul>
Optional:	<ul style="list-style-type: none"> <li>• Linearity test module (LinTest PFM 20)</li> <li>• Display and operation unit (DUx 20)</li> </ul>
<i>Special models are possible on request.</i>	

## Dust concentration measuring device OPM 19 ED



• QAL1 approval according to  
DIN EN 15267-1, DIN EN 15267-2,  
DIN EN 15267-3, DIN EN 14181 in  
progress

### APPLICATION

The measuring gas is sampled by a temperature-controlled probe, conveyed to a measuring cell and continuously diluted and dried with hot and dust-free ambient air. The dust measurement is based on optical scattered light measurement. Thereby the device is streamed with the measuring air and the dust content is measured by the optical sensor. In the electronics of the device the measuring signal is converted to an equivalent dust signal.

### INSTALLATION EXAMPLE

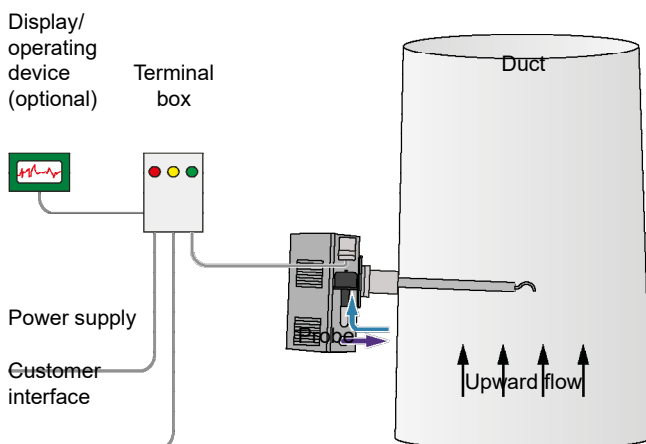

### YOUR BENEFITS AT A GLANCE

- relatively small required space
- compact device → only 1 sample flange with integrated or separated return fitting necessary
- display option in  $\text{mg}/\text{m}^3$  by input of calibration parameters
- integrated isokinetic gas sampling
- visualisation and operating via PC software or optional display/operating device

### PRECONDITIONS ON SITE

- ambient temperature:  $-20\dots+50\text{ °C}$
- relative humidity: max. 90% (non-condensing)
- location free of percussion
- installation place with run-in/run-out zone of min. 5-fold/2-fold length of duct diameter
- flow measuring device (optional to measure actual duct flow for setting of isokinetics)

FUNCTIONAL SCHEME

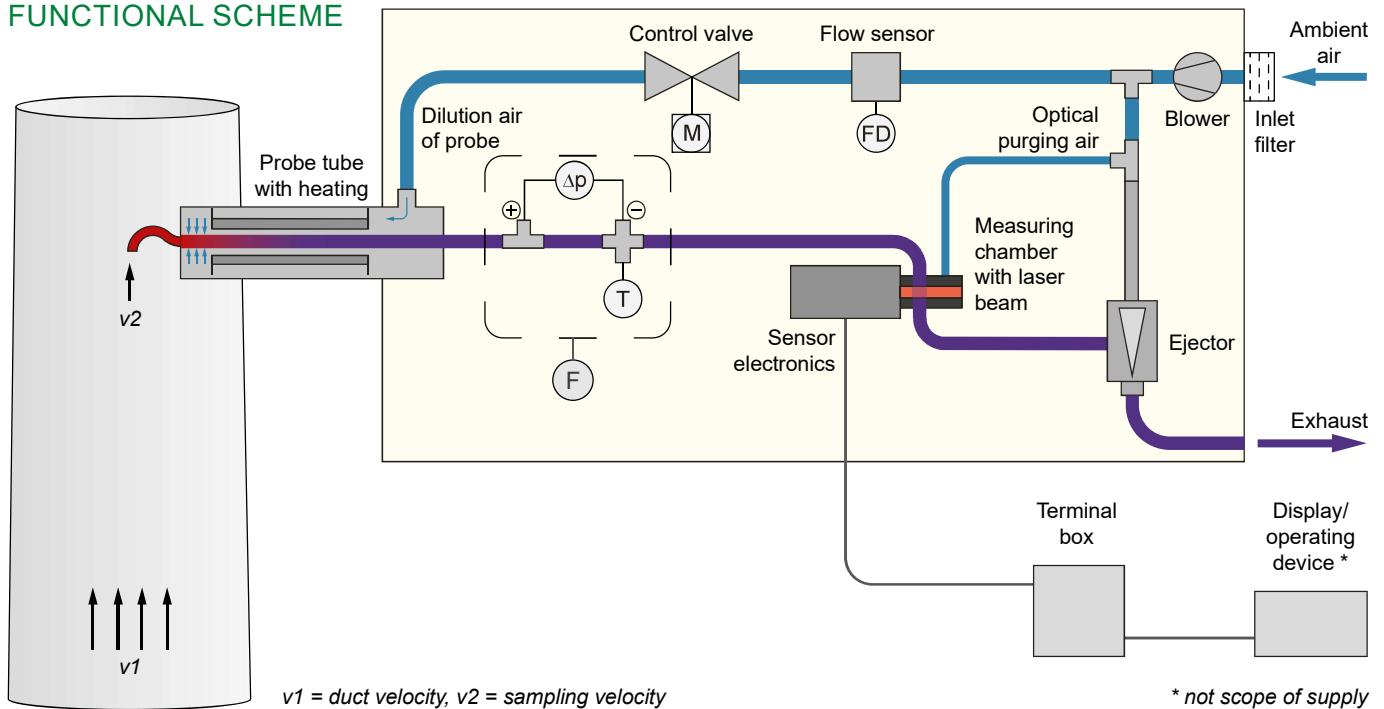

TECHNICAL DATA

Probe:	extractive sampling with GRP weather protection casing, IP55; approx. 440 x 640 x 1,340 mm (w x h x d), 35 kg immersion depth: max. 1.000 mm; cable length to terminal box: max. 2 m
Terminal box:	steel sheet housing, IP65; approx. 300 x 400 x 210 mm (w x h x d), 13 kg
Display / Operating:	via PC software or optional display/operating device
Media temperature:	max. 180 °C
Exhaust humidity:	rel. humidity: 100%
Flow of measuring gas:	2.5...3.5 m <sup>3</sup> /h (sucked measuring gas and dilution air)
Pressure on ambience:	-30...+2 hPa
Measuring range:	dust (in operation) 0...7.5 mg/m <sup>3</sup> (max. 250 mg/m <sup>3</sup> )
Operational availability:	after 5 to 15 min (without preheating)
Control function:	zero and reference point check; zero point/pollution correction
Calibration:	via gravimetric comparison measurement
Analogue output:	4...20 mA, galvanically isolated with common ground, burden max. 500 Ω
Analogue input:	4...20 mA, galvanically isolated, for external velocity of isokinetic gas sampling
Digital outputs:	2 x potential-free contact, max. 35 V UC, 0.4 A (for failure and maintenance)
Digital input:	optional, external switch contact for switch-over between measuring gas and ambient air
Interfaces:	Modbus VDI (RS485), Modbus Display (RS485), USB connection for PC software
Process connection:	flange DN 80 PN 6, special design: tube Ø 100 mm
Clip contacts:	max. 2.5 mm <sup>2</sup>
Power supply:	110V/AC or 230VAC 50/60Hz (automatic detection), 1 kVA
Optional:	<ul style="list-style-type: none"> <li>display/operating device</li> <li>probe length with immersion depth of 1,500 mm</li> </ul>
<i>Special models are possible on request.</i>	

# Ambient air monitoring



Pollutants such particulate matter (PM 2.5) and nitrogen dioxide (NO<sub>2</sub>) in the air are harmful to health. For their measurement complex and expensive measurement technology is often used.

Dr. Födisch Umweltmesstechnik AG developed compact and low-cost measuring devices for ambient air monitoring and industrial applications.

Whether the application is for outdoor, indoor, stationary or mobile – the device handling is easy, the measurements are precise and independent from the

weather conditions. By means of preconditioned air, the particulate matter and NO<sub>2</sub> content of the air is measured in real time. By WLAN, the devices can be linked to other air quality / climate sensors to achieve an efficient, meaningful environmental monitoring.

Fields of applications are:

- industrial areas, production halls and workplaces, urban areas
- ambient air monitoring, air management systems, traffic control and routing

## Stationary particulate matter monitoring

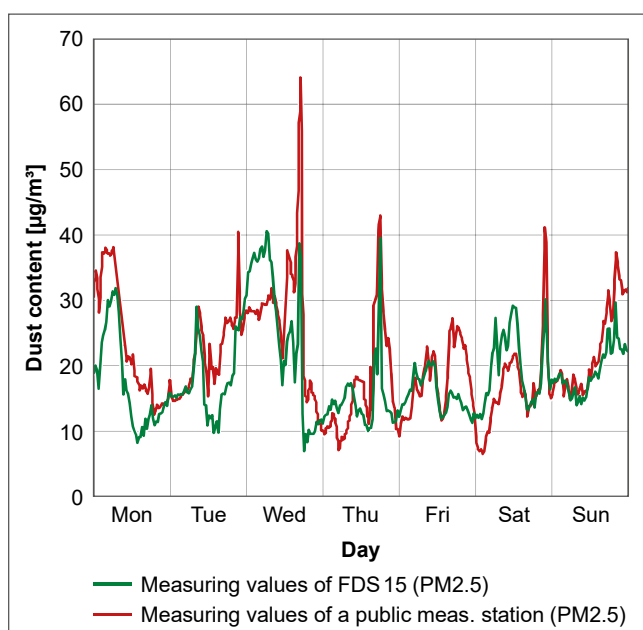

## Mobile particulate matter measurement

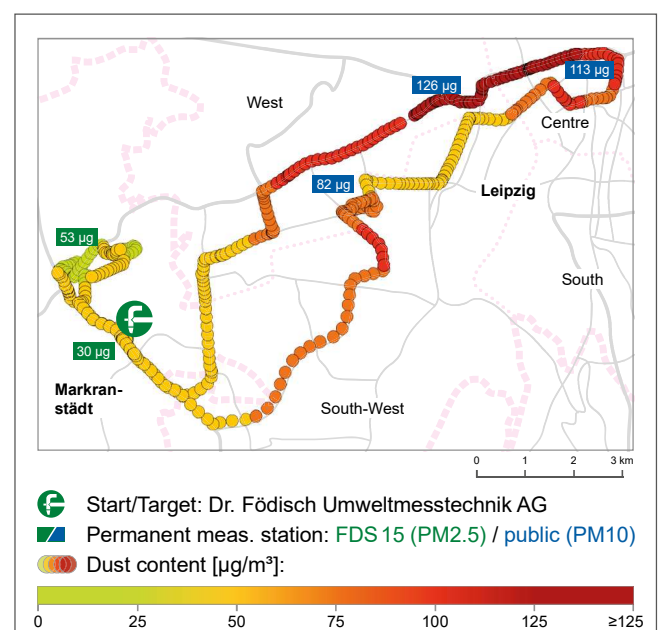

## Ambient air monitoring devices by comparison

	FDS 15	FDS 17
<b>Field of application</b>		
Continuous measurement and monitoring	•	•
Indoor and outdoor measurement	•	•
Mobile use		
<b>Device characteristics</b>		
Measuring principle:		
• Optic (Scattered light measurement)	•	•
• Reference sensor	•	•
• Electrochemical		
Electrostatic precipitator	• <sup>[1]</sup>	•
Gas conditioning	•	•
Data transfer:		
• RS485 / Modbus RTU	•	•
• 4...20 mA current loop	• <sup>[1]</sup>	• <sup>[1]</sup>
• WLAN module	• <sup>[1]</sup>	• <sup>[1]</sup>
Other device features:		
• Integrated display/operating unit		
• Detached display/operating unit (as optional additional device)	•	•
• Suction from the bottom	•	
• Suction from above (via measuring gas sampling probe)		•
• Metal housing	•	•
• Plastic housing		
• Power supply 100-240 V AC	•	•
• Power supply 12-24 V DC	•	•
<b>Measuring components</b>		
TSP	•	
PM 10		•
PM 2.5	•	
PM 10 and PM 2.5 simultaneously		•
NO <sub>2</sub>		
<sup>[1]</sup> optionally available		



### Fine dust sensor FDS 15

Optical sensor for continuous measurement and monitoring of fine dust contents indoor and outdoor



#### APPLICATION

The fine dust sensor FDS 15 establishes a new class of air quality monitoring – in environment as well as at work places.



Measuring value analysis via WLAN

#### COMPARISON MEASUREMENT

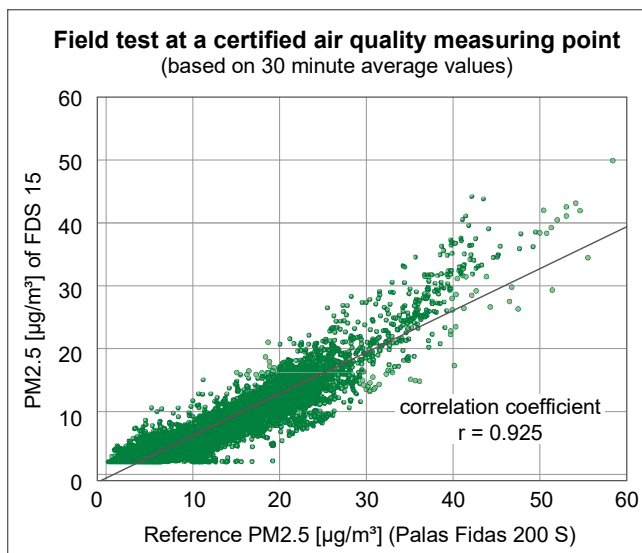

#### YOUR BENEFITS AT A GLANCE

- real-time measurement (PM10 or PM2.5)
- robust design
- active suction
- high accuracy through measuring gas conditioning
- long-term stability through two sensors
- cross linking of several FDS 15
- network-compatible, WLAN
- easy installation without special tool
- low operational costs
- patented electrostatic precipitator for zero point setting (optional)

#### PRECONDITIONS ON SITE

- ambient temperature: -20...+50 °C
- relative humidity: 0...95%
- place with representative dust loading
- protection against draught
- no direct solar radiation
- location free of percussion
- power supply
- signal connection (Modbus / mA / WLAN)



## INSTALLATION EXAMPLE

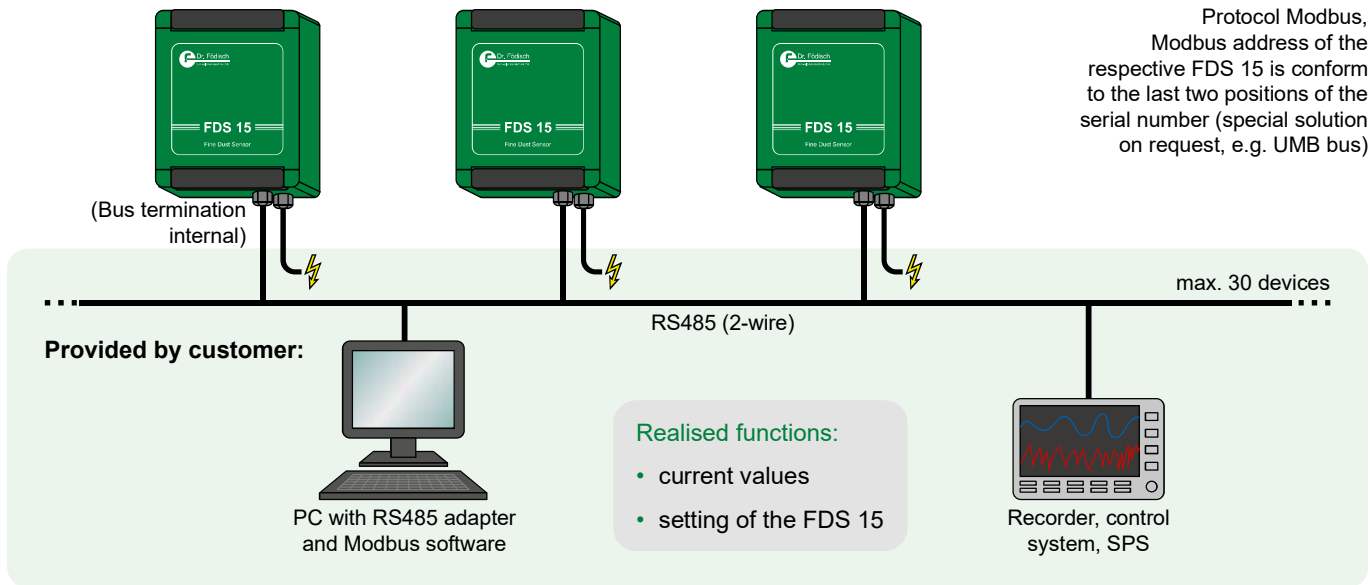

## TECHNICAL DATA

Housing:	compact sensor housing made of aluminium; IP33
Dimensions:	130 mm x 160 mm x 90 mm (w x h x d)
Weight:	approx. 2 kg
Ambient temperature:	-20...+50 °C
Relative humidity:	0...95%
Measuring method:	scattered light measurement
Average dust contents:	up to 200 µg/m <sup>3</sup> (with electrostatic precipitator up to 500 µg)
Detection limit:	2 µg/m <sup>3</sup>
Flow:	2 l/min
Sensors:	2x optical sensor; separated control and signal evaluation
Zero point setting:	automatic, interval 2-8 h (optional by internal electrostatic precipitator with high voltage module, approx. 10 kV)
Fan:	for flow enforcement
Heating:	for conditioning of measuring gas (compliance with the dew-point spread), integrated over temperature protection
Interface:	RS485 (Modbus)
Clip contacts:	max. 0.5 mm; power supply connection: max. 2.5 mm
Power supply:	100-240 V AC, 0.7 A, 50-60 Hz (optional 12-24 V DC, 2.1 A); pre-fuse min. 5 A
Optional:	<ul style="list-style-type: none"> <li>• 4...20 mA current loop</li> <li>• WLAN module</li> <li>• pre-separator with regulated heating</li> <li>• electrostatic precipitator</li> </ul>

*Special models are possible on request.*

## Fine dust sensor FDS 17

Optical sensor for continuous, simultaneous measurement and monitoring of fine dust contents PM10 and PM2.5 indoor and outdoor



### SCHEMATIC DESIGN

A Sensor module for measurement of PM10  
 B Sensor module for measurement of PM2.5

- 1 Measuring sensor
- 2 Reference sensor
- 3 Pre-separator
- 4 Residual dust reservoir
- 5 Fan

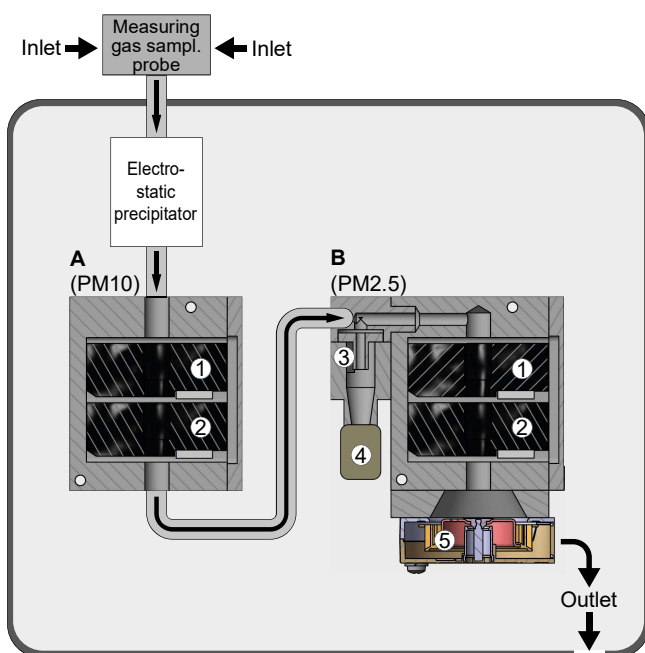

### YOUR BENEFITS AT A GLANCE

- simultaneous real-time measurement of PM10/ TSP and PM2.5
- patented electrostatic precipitator for zero point setting
- robust design
- active suction
- long-term stability
- cross linking of several FDS 17
- network-compatible, WLAN
- easy installation without special tool
- low operational costs

### PRECONDITIONS ON SITE

- ambient temperature: -20...+50 °C
- relative humidity: 0...95%
- place with representative dust loading
- protection against draught
- no direct solar radiation
- location free of percussion
- power supply
- signal connection (Modbus / mA / WLAN)

INSTALLATION EXAMPLE

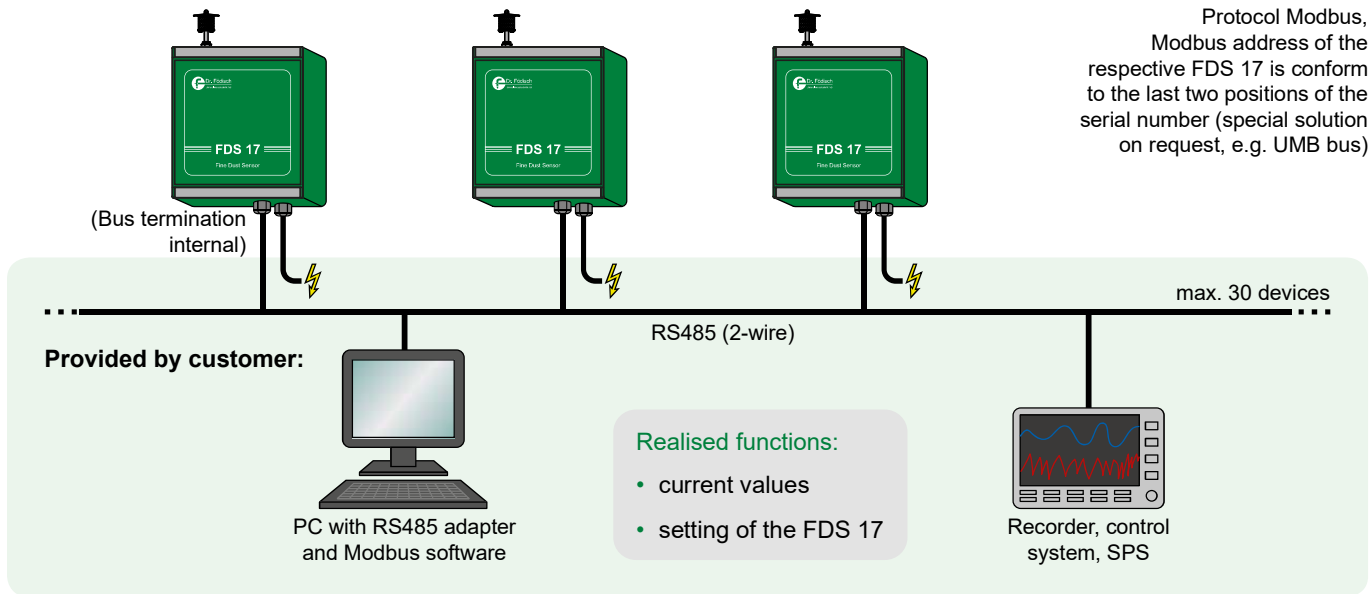

TECHNICAL DATA

Housing:	compact sensor housing made of aluminium; IP33
Dimensions:	200 mm x 313 mm x 121 mm (w x h x d)
Weight:	approx. 4 kg
Ambient temperature:	-20...+50 °C
Relative humidity:	0...95%
Measuring method:	scattered light measurement
Average dust contents:	up to 500 µg/m <sup>3</sup> (max. 2000 µg/m <sup>3</sup> )
Detection limit:	2 µg/m <sup>3</sup>
Flow:	2 l/min
Sensors:	2x sensor module with two optical sensors for each; separated control and signal evaluation
Zero point setting:	automatic by internal electrostatic precipitator with high voltage module, approx. 10 kV; interval 2-8 h
Fan:	for flow enforcement
Heating:	for conditioning of measuring gas (compliance with the dew-point spread), integrated over temperature protection
Interface:	RS485 (Modbus)
Clip contacts:	max. 0.5 mm; power supply connection: max. 2.5 mm
Power supply:	100-240 V AC, 0.7 A, 50-60 Hz (optional 12-24 V DC, 2.1 A); pre-fuse min. 5 A
Optional:	<ul style="list-style-type: none"> <li>• 4...20 mA current loop</li> <li>• WLAN module</li> </ul>

*Special models are possible on request.*

# Hot-wet gas analysis



Die Dr. Födisch Umweltmesstechnik AG succeeded in the challenge of developing simple devices with low demand for maintenance as well as multi-component measuring devices with an option for remote monitoring and service.

Device-internal cycles for maintenance and auto-calibration affecting availability are reduced to a minimum. Maintenance intervals shall be at least 3 months or even longer (6 months). Moreover, a modular construction offers the possibility to minimize maintenance related downtime due to an optimized spares pooling.

Our modern hot-wet gas analysers match perfectly with these requirements. A partial flow of gaseous components is withdrawn by a sampling probe and led to the analyser via a sampling pipe. The sample gas is tempered at about 185 °C for the whole gas path and monitored for flow and temperature. This high temperature level is necessary in order to prevent condensing water-soluble components.

The systems can measure up to twelve components e.g. HCl, NH<sub>3</sub>, H<sub>2</sub>O, CO, NO, NO<sub>2</sub>, CH<sub>4</sub>, SO<sub>2</sub>, CO<sub>2</sub>, among others.

Oxygen is measured by an integrated zirconium dioxide sensor (standard) and TOC as well as NMHC measurement is carried out by Flame-Ionisation-Detector FID.

Apart from CEMS installations compliant with EN 15267-3 (QAL1 / MCERTS), it is possible to use the analysers for process measurements, e.g. before and after DeNOx or DeSOx plants. Line switching is another possibility due to its rather easy handling.

Mobile measuring equipment offers high flexibility for temporary monitoring, e.g. test installations and reference measurements. The hot-wet gas analysers are widely used amongst others in:

- power plants
- incinerators for waste, biomass, sludge and hazardous substances
- pulp and paper industry
- glass melting plants
- cement industry

## Example for simplified gas circuit diagram

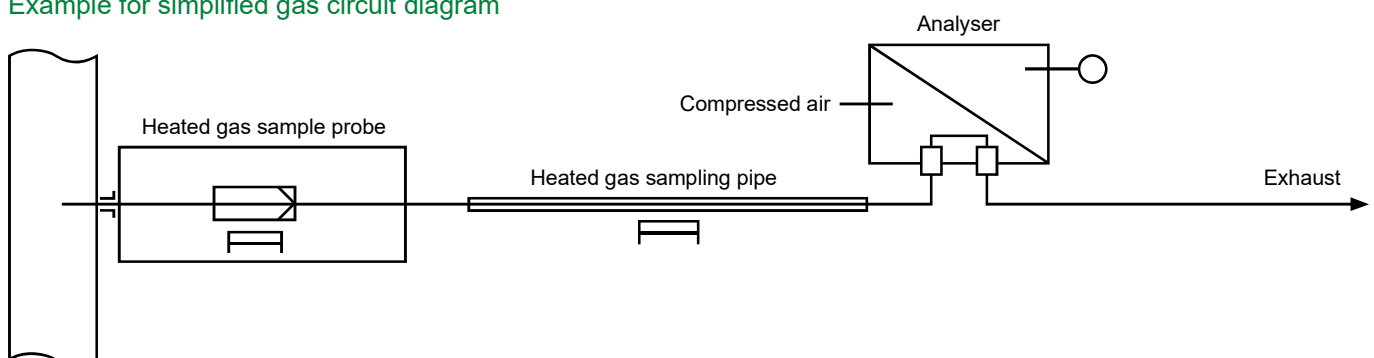

## Application examples for hot-wet gas analyser systems

### MULTI-COMPONENT GAS ANALYSER MCA 10

- ISO 9001 certified manufacturing in Germany
- high performance manufacturer's calibration
- low demand for maintenance - Certified maintenance interval of 6 months incl. O<sub>2</sub>
- advanced Emission monitoring and process control
- >1,000 installations for various applications



### FID 22 FOR MONITORING OF THC, CH<sub>4</sub> & NMHC

- TOC analyser for gases - Single range/no switch: 0 ... 10,000 mg C/m<sup>3</sup>
- low operating expenses - Combustion air from ambient air via internal catalyst, Zero and test gas consumption: approx. 1 l/min, Fuel gas consumption: H<sub>2</sub> approx. 30 ml/min
- high performance for continuous TOC measurement - Standard heating temperature about 190 °C, Repeatability: +/- 1 % of range, Zero drift: +/- 1 % in 24 h, Oxygen cross-sensitivity < 2 %
- continuous NMHC measurement - Real dual channel FID, 3 measured values (THC, CH<sub>4</sub>, NMHC) at the same time, H<sub>2</sub> or HeH<sub>2</sub> as fuel gas, Hydrogen fuel approx. 70 ml/min
- modern communication - Remote control function via Virtual Network Computing, Remote control function via Virtual Network Computing and TCP/IP interface for easy data transfer

Applications in:

- sorting of waste
- LEL monitoring and process control in chemical industry
- SHED applications
- automotive applications
- indoor VOC control
- toxic concentrations of solvent vapours
- leak detection and monitoring of fuel storage facilities
- strippable gases



## Hot-wet gas analysers for stationary applications by comparison

	MCA 10 HWIR	UVA 17 HW	FID 22 TOC	FID 22 NMHC	MCA 10 maritime
<b>Field of application</b>					
Process measurement	●	●	●	●	●
TUV-approved CEMS/analyser for combustion and incineration plants	● <sup>[1]</sup>		●		
DNV-approved emission measurement and process control of exhaust treatment systems at sea shipping					● <sup>[2]</sup>
<b>Device characteristics</b>					
Measuring principle:					
• Infrared photometer	●				●
• UV spectrometer		●			
• Zirconium dioxide sensor (O <sub>2</sub> )	●	●			●
• Flame ionisation detector	● <sup>[3]</sup>		●	●	
Data transfer:					
• Analogue outputs 4...20 mA	●	●	●	●	●
• Digital outputs (e.g. limit value 1/2, maintenance request, maintenance, failure)	●	●	●	●	●
• RS232 / Modbus RTU	●	●	●	●	●
• RS485 / Modbus RTU	●		●	●	●
• Profibus	●		●	●	●
• Remote access	●	●	● <sup>[5]</sup>	● <sup>[5]</sup>	●
• Signal integration of external signals	●				●
Other device features:					
• Integrated display/operating unit		●	●	●	
• Detached display/operating unit	●				●
• Data logger function	● <sup>[4]</sup>	●	●	●	●
• Integrated thermal printer					
• Integrated gas conveyance (ejector resp. pump)	●	●	●	●	●
• Operation without compressed air					
<b>Measuring components</b>					
Max. quantity of simultaneously detectable components	12	12	1	2	12
Max. quantity of simultaneously output components (for analogue outputs)	12	8	1	2	8
CO Carbon Monoxide	●				●
CO <sub>2</sub> Carbon Dioxide	●				●
NO Nitrogen Monoxide	●	●			●
NO <sub>2</sub> Nitrogen Dioxide	●	●			●
N <sub>2</sub> O Nitrous Oxide	●				●
NH <sub>3</sub> Ammonia	●	●			●
SO <sub>2</sub> Sulphur Dioxide	●	●			●
CH <sub>4</sub> Methane	●			●	●
CH <sub>2</sub> O Formaldehyde	●	●			
HCl Hydrogen Chloride	●				
HF Hydrogen Fluoride	●				
H <sub>2</sub> S Hydrogen Sulfide		●			
Cl <sub>2</sub> Chlorine		●			
TOC Total Organic Carbon	● <sup>[3]</sup>		●	●	
NMHC Non-Methane Hydrocarbons				●	
H <sub>2</sub> O Water Vapour	●				●
O <sub>2</sub> Oxygen	●	●			●
... other components on request		●			
<sup>[1]</sup> suitability tested according to EN 15267-3, certified in compliance with QAL1 and MCERTS Performance Standards; <sup>[2]</sup> certified in compliance with MEPC.259(68), tested according to DNV GL CG-0339; <sup>[3]</sup> by further module in case of system construction; <sup>[4]</sup> only external via USB; <sup>[5]</sup> option					

## Portable hot-wet gas analysers for temporary monitoring by comparison

	MCA 16 m	FID 22 m TOC	FID 22 m NMHC
<b>Field of application</b>			
Process measurement	•		•
TUV-approved analyser		•	
<b>Device characteristics</b>			
Measuring principle:			
• Infrared photometer	•		
• UV spectrometer			
• Zirconium dioxide sensor (O <sub>2</sub> )	•		
• Flame ionisation detector		•	•
Data transfer:			
• Analogue outputs 4...20 mA		•	•
• Digital outputs (e.g. limit value 1/2, maintenance request, maintenance, failure)		•	•
• RS232 / Modbus RTU		•	•
• RS485 / Modbus RTU		•	•
• Remote access	•	• <sup>[2]</sup>	• <sup>[2]</sup>
Other device features:			
• Integrated display/operating unit		•	•
• Detached display/operating unit	•		
• Data logger function	• <sup>[1]</sup>	•	•
• Integrated gas conveyance (ejector resp. pump)	•	•	•
• Operation without compressed air	•		
<b>Measuring components</b>			
Max. quantity of simultaneously detectable components	12	1	2
Max. quantity of simultaneously output components (for analogue outputs)	-	1	2
CO Carbon Monoxide	•		
CO <sub>2</sub> Carbon Dioxide	•		
NO Nitrogen Monoxide	•		
NO <sub>2</sub> Nitrogen Dioxide	•		
N <sub>2</sub> O Nitrous Oxide	•		
NH <sub>3</sub> Ammonia	•		
SO <sub>2</sub> Sulphur Dioxide	•		
CH <sub>4</sub> Methane	•		•
CH <sub>2</sub> O Formaldehyde			
HCl Hydrogen Chloride	•		
HF Hydrogen Fluoride			
H <sub>2</sub> S Hydrogen Sulfide			
Cl <sub>2</sub> Chlorine			
TOC Total Organic Carbon		•	•
NMHC Non-Methane Hydrocarbons			•
H <sub>2</sub> O Water Vapour	•		
O <sub>2</sub> Oxygen	•		
... other components on request			
<sup>[1]</sup> external via USB;			
<sup>[2]</sup> option			



## Multi component analyser MCA 10 HWIR

Extractive measuring system for continuous emission monitoring of pollutants in flue gas and for process control



- certified in compliance with MCERTS Performance Standards
- certificate no.: Sira MC140256/01



- EN 15267, QAL1, Cert.-No.: 1729865-ts
- TUV-approved CEMS for combustion and incineration plants (as system part)



- certified in compliance with GOST
- certificate no.: MFI-242-1852-2015



National Institute of Environmental Research  
Certification of Republic of Korea



### APPLICATION

The system consists basically of three units:

- Multi component analyser MCA 10 HWIR
- evaluation computer with user software
- PLC for analyser system

MEASURING RANGES			
	Certific. range	Meas. range 2	Meas. range 3
CO:	0...75 mg/m <sup>3</sup>	0...300 mg/m <sup>3</sup>	0...5000 mg/m <sup>3</sup>
CO <sub>2</sub> :	0...25 vol. %	0...50 vol. %	-
NO:	0...80 mg/m <sup>3</sup>	0...400 mg/m <sup>3</sup>	0...3000 mg/m <sup>3</sup>
NO <sub>2</sub> :	0...50 mg/m <sup>3</sup>	0...500 mg/m <sup>3</sup>	-
N <sub>2</sub> O:	0...50 mg/m <sup>3</sup>	0...3000 mg/m <sup>3</sup>	-
NH <sub>3</sub> :	0...10 mg/m <sup>3</sup>	0...50 mg/m <sup>3</sup>	0...500 mg/m <sup>3</sup>
SO <sub>2</sub> :	0...75 mg/m <sup>3</sup>	0...300 mg/m <sup>3</sup>	0...2500 mg/m <sup>3</sup>
CH <sub>4</sub> :	0...50 mg/m <sup>3</sup>	0...500 mg/m <sup>3</sup>	-
CH <sub>2</sub> O <sup>[1]</sup> :	0...10 mg/m <sup>3</sup>	0...20 mg/m <sup>3</sup>	0...100 mg/m <sup>3</sup>
HCl:	0...15 mg/m <sup>3</sup>	0...90 mg/m <sup>3</sup>	0...5000 mg/m <sup>3</sup>
HF:	-	0...20 mg/m <sup>3</sup>	-
TOC:	0...15 mg/m <sup>3</sup>	0...30 mg/m <sup>3</sup>	0...500 mg/m <sup>3</sup>
H <sub>2</sub> O:	0...40 vol. %	-	-
O <sub>2</sub> :	0...25 vol. %	-	-

<sup>[1]</sup> suitability test in progress  
Other components and measuring ranges on request.

### YOUR BENEFITS AT A GLANCE

- modularly structured hot gas analyser system (without gas cooler)
- up to twelve infrared components
- field-proven components, modern photometer technology
- long operation times, high reliability (6 months maintenance interval)
- pre-calibrated → immediately deployable
- integrated control, integrated zero gas provision
- self-control (additional control of inlet temperature)
- zero point drift control
- remote diagnosis and system setting via Ethernet
- connection of external device (TOC, Hg)

### PRECONDITIONS ON SITE

- ambient temperature: 5...40 °C
- installation place indoors and dust-free with protection against percussions/vibrations
- power supply and PC/laptop/tablet\* with USB interface (resolution min. 1024 x 768 Pixel; Windows XP Professional upwards for installation of delivered user software)
- instrument air according to ISO 8573.1, class 2
- appropriate gas sampling

\* not necessary for system application

TECHNICAL DATA	
<b>Analyser</b>	
Housing:	steel sheet housing, 19" format; IP40; 480 mm x 220 mm x 350 mm (w x h x d), approx. 28 kg
Measuring methods:	<ul style="list-style-type: none"> <li>• bi-frequency measuring method (NO<sub>2</sub>, SO<sub>2</sub>, CH<sub>2</sub>O<sup>[1]</sup>, HF, H<sub>2</sub>O, CO<sub>2</sub>)</li> <li>• gas filter correlation (CO, NO, HCl, NH<sub>3</sub>, N<sub>2</sub>O, CH<sub>4</sub>)</li> <li>• zirconium dioxide sensor (O<sub>2</sub>)</li> </ul>
Number of meas. components:	up to 12 infrared components (dependent on application) and oxygen
Accuracy:	< 2% of the respective measuring range
Sensitivity correction:	with test gas, once in 6 months (sensitivity tests as standard with a concentration of 80% of the measuring range)
Standardisation:	dry, wet
Gas conveyance:	air-jet pump
Forced air supply:	1...4 bar depending on flow rate
Display / Operating:	PC connection via USB (e.g. to the control panel in the analyser cabinet)
Interfaces:	2x RS232, USB
Power supply:	110 V bis 230 V, 50/60 Hz, 300 W
Other functions:	gas path continuously heated (standard 185 °C, higher temperatures on request), cross-sensitivity correction, air pressure correction, automatic zero point correction
<b>Analyser cabinet</b>	
Housing:	steel sheet cabinet; 826 mm x 2100 mm x 600 mm (w x h x d), approx. 200...300 kg (dependent on application)
Display / Operating:	integrated 15" control panel with touch surface, 1024 x 768 Pixel
<b>System</b>	
Ambient conditions:	5...40 °C; relative humidity: max. 90% (non-condensing)
Compressed-air supply:	4...6 bar (dependent on application)
Compressed-air consumption:	approx. 1 m <sup>3</sup> /h (dependent on application)
Calibration:	<ul style="list-style-type: none"> <li>• zero point: automatical with instrument air;</li> <li>• span point: with test gas, optionally automatical</li> </ul>
Interfaces:	analogue outputs, Modbus, Profibus, further on request
Inputs:	for analogue and digital signals
Outputs:	Analogue outputs: 4...20 mA; Digital outputs: failure, maintenance, maintenance requirement, measuring range switch-over, other
Remote control:	Ethernet, analogue modem
Power supply:	230 V or 400 V / 50 Hz, 350 W (dependent on application) / 4000 W (analyser cabinet, air conditioner, probe) + 125 W/m measuring gas pipe
<p><sup>[1]</sup> suitability test in progress Special models are possible on request.</p>	

## Hot gas UV analyser UVA 17 HW

Hot-wet spectrometer-based gas analyser for measurement of pollutants in flue gas with low concentrations and for process control



### APPLICATION

The UV analyser UVA 17 HW can be used for monitoring of e.g. NO, NO<sub>2</sub>, NH<sub>3</sub>, SO<sub>2</sub> and O<sub>2</sub> in incineration plants as well as for process measurements in the chemical and pharmaceutical industry.

This analyser is based on a heated spectrometer and measures all UV absorbing gas components. An ejector supplies the sample gas. Due to the heated measuring cell (200 °C) an elaborate gas conditioning is not required. The applied Xenon flash light is characterised by a 2 to 3 times higher lifetime compared to other light sources.

The integrated zirconium dioxide sensor serves the oxygen measurement. A small PC with 7" colour display and an app-based menu allow an intuitive operation on site as well as remotely.

### PRECONDITIONS ON SITE

- installation place indoors and dust-free
- protection against wetness
- protection against percussions/vibrations
- instrument air according to ISO 8573.1, class 2
- appropriate gas sampling

### YOUR BENEFITS AT A GLANCE

- compact design
- long-term stable signal
- hot gas measurement up to 200 °C
- no gas conditioning, no gas cooler needed
- low-maintenance measuring gas conveyance by ejector
- user-friendly touch display
- extension of measuring components without additional hardware possible
- remote access

### MEASURING RANGES

Component	Meas. range 1	Meas. range 2
NO:	0...50 mg/m <sup>3</sup>	0...5,000 mg/m <sup>3</sup>
NO <sub>2</sub> :	0...100 mg/m <sup>3</sup>	0...5,000 mg/m <sup>3</sup>
NH <sub>3</sub> :	0...10 mg/m <sup>3</sup>	0...1,000 mg/m <sup>3</sup>
SO <sub>2</sub> :	0...50 mg/m <sup>3</sup>	0...5,000 mg/m <sup>3</sup>
H <sub>2</sub> S:	0...300 mg/m <sup>3</sup>	0...3,000 mg/m <sup>3</sup>
Cl <sub>2</sub> :	0...300 mg/m <sup>3</sup>	0...3,000 mg/m <sup>3</sup>
CHOH:	0...100	0...5,000 mg/m <sup>3</sup>
O <sub>2</sub> :	0...25 vol. %	0...25 vol. %

*Other components (e.g. Hg<sup>0</sup>) and measuring ranges on request.  
Combination of measuring components and ranges is limited.*

## SCHEMATIC DESIGN

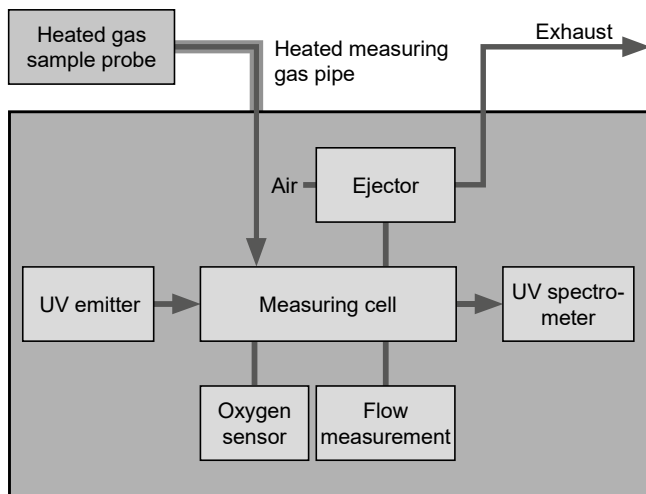

## FUNCTION

The function of the UV analyser is based on the measurement of an integrated spectrometer in the spectral range of ultraviolet radiation of 180 to 400 nm. Fundamentally, the device is composed of light source, measuring cell and spectrometer which are interconnected via the optical path. The emitted radiation is absorbed partly by the process gas in the measuring cell and detected by a spectrometer afterwards. By using a chemometric model the gas component as well as the concentration can be determined.

Because of the modular design, there is the possibility for application of different spectrometers for adaptation to variable requirements.

## TECHNICAL DATA

Housing:	robust housing with compact 19" format, IP40; 483 mm x 133 mm x 350 mm (w x h x d), approx. 12 kg
Measuring methods:	<ul style="list-style-type: none"> <li>• spectrometer 180-400 nm (NO<sub>2</sub>, SO<sub>2</sub>, NO, NH<sub>3</sub>, CH<sub>2</sub>O, H<sub>2</sub>S, Cl<sub>2</sub>, Hg<sup>0</sup>)</li> <li>• zirconium dioxide sensor (O<sub>2</sub>)</li> </ul>
Number of meas. components:	up to 12 components (dependent on application) and oxygen
Accuracy:	< 2% of the respective measuring range
Ambient conditions:	5...40 °C (temperature stability max. 5 K/h); humidity: max. 90% (non-condensing)
Optical bench:	<ul style="list-style-type: none"> <li>• gas path: continuously heated, standard 200 °C (higher temperatures on request)</li> <li>• path length of measuring cell: adjustable               <ul style="list-style-type: none"> <li>- short path cell: 260 mm</li> <li>- long path cell: 730 mm</li> </ul> </li> <li>• particle filter: 2 µm</li> </ul>
Zero point setting:	automatically with instrument air
Measuring gas conveyance / flow rate:	via ejector / 100-200 l/h
Display / operating:	7" touch display, 800 x 480 Pixel, status messages for failure, maintenance and maintenance request; Language selection: German, English, French, Chinese
Data storage:	data logger function
Interfaces:	RS232 (Modbus)
Inputs / outputs:	<ul style="list-style-type: none"> <li>• 8 analogue outputs, 4...20 mA, potential-free, burden max. 500 Ω</li> <li>• 14 digital inputs (optocoupler), max. 30 V</li> <li>• 16 digital outputs, potential-free, max. 60 V, 500 mA</li> </ul>
Remote control:	VNC, remote control via PC
Power supply:	110-250 V AC / 50-60 Hz, 350 W
Other functions:	integrated flow measurement; integrated pressure monitoring
<i>Special models are possible on request.</i>	

## Flame Ionisation Detector FID 22 TOC

Flame Ionisation Detector for continuous monitoring of hydrocarbons in exhaust gases and ambient air

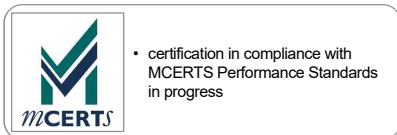
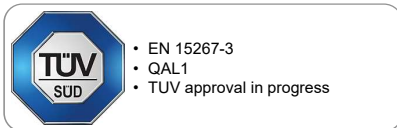

### APPLICATION

The FID 22 TOC is an analyser with a high precise flame ionisation detector and is designed for stationary use.

The analyser works extractively, i.e. the sample gas is extracted from the gas channel by means of a gas sampling probe using a heated pre-filter and fed to the analysis system via a heated sample gas line.

During operation the whole gas path is heated to 190 °C (optional 300 °C).

The analyser is developed for continuous monitoring of concentration of hydrocarbons in gases from industrial plants (emissions) or environments (immissions).

The device is used for stack gas measurement in:

- natural gas industry
- petrochemical industry
- pharmaceutical industry
- incineration plants
- plants for landfill and sewage gas recovery

### PERFORMANCE

Measuring range:	0...100,000 mg C/m <sup>3</sup>
Repeatability:	+/- 1 % of range
Zero drift:	+/- 1 % in 24 h
Response time:	about 1 sec. (T <sub>90</sub> ; at sample gas inlet)
Warm-up time:	15 minutes

### YOUR BENEFITS AT A GLANCE

- certification according to EN 15267-3 QAL1 and MCerts in progress
- low Oxygen interference (< 2 %)
- Hydrogen consumption (fuel) about 30 ml/min
- performing an automatic calibration (AutoCal)
- integrated catalytic converter for fuel gas processing, replacement of filling only every 5 - 7 years
- automatic pressure and sample gas flow control
- single range - no switch between ranges
- heated sample gas filter
- compensation of sensitivity using response factors
- variable sample flow
- internal datalogging by USB drive flash
- user-friendly 7" touch display and software
- graphic display of HC-concentration
- pyrolysis cleaning function for a self-cleaning procedure of the gas path and cell
- built in zero gas generator (option)
- device version with injector available

## BACKSIDE OF 19" RACK



## OPTIONAL EQUIPMENT

- tablet for remote control, consisting of: internal router, Samsung tablet 10" with high-resolution touch display
- FID 22 line (heated sample gas line)
- FID 22 filter (heated pre-filter)
- FID 22 measuring gas probe

## PRECONDITIONS ON SITE

- installation place indoors and dust-free
- protection against wetness
- protection against percussions/vibrations
- power supply
- periphery (gas probe and a heated measuring gas line)
- operating gases

## MEASURING PRINCIPLE

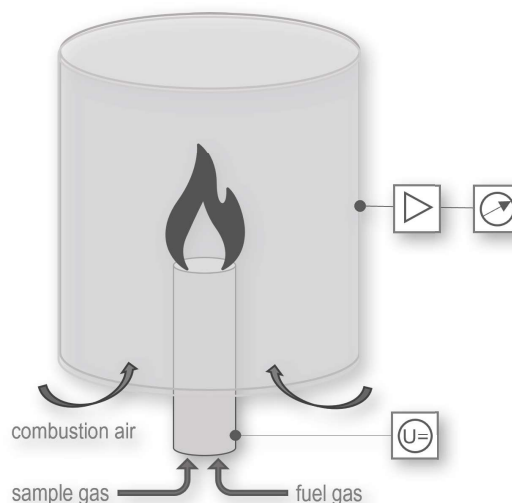

## OPERATION PRINCIPLE

The FID 22 TOC uses a flame ionization detector (FID) to measure hydrocarbons.

In the FID chamber a hydrogen flame burns in an electrical field and fed by high purity fuel gas as well as an absolutely hydrocarbon-free combustion air. The sample gas to be analyzed is also fed into this flame

The hydrocarbons in the sample gas are "cracked" and the HC fragments are ionized. An ion current in the order of 10 - 14 A is generated in the electric field.

## TECHNICAL DATA

Protection class	IP40
Dimension; weight:	133 x 482 x 420 mm (w x h x d); 12 kg
Heating temperature:	detector 190 °C (optional 300 °C)
Gas requirements (consumption):	Fuel gas H <sub>2</sub> 5.0 (about 1.8 l/h) Zero and span gas Propane and synthetic air (about 60 l/h) Combustion air ambient air, conditioning using integrated catalytic converter (standard), external combustion air generator (option)
Ambient conditions:	Ambient temperature 5°C ... +45°C (during application) Relative air humidity max. 95 % (without condensate formation)
Pressure compensation:	-150...+500 mbar
Display:	7" TFT - Touch
Remote control:	VNC / FID 22 Master
Outputs:	Analogue 0...20 mA, 0...10 V (2 x ; with living zero point at 4 mA, burden 300 Ω) Digital Ethernet - RS232
Power supply:	115 / 230 V, 50...60 Hz, 350 W



## Flame Ionisation Detector FID 22 NMHC

Flame Ionisation Detector for continuous monitoring of non-methane hydrocarbons, total hydrocarbon content and Methane



- EN 15267-3
- QAL1
- TUV approval in progress



### APPLICATION

The FID 22 NMHC Analyser (19" rack) measures with its built in NMHC cutter the Methane concentration and parallel in a second channel also the total hydrocarbon content (THC) as well as the non-methane hydrocarbon content (NMHC).

The NMHC analyser is designed for stack gas emission monitoring, ambient air monitoring, thermal reactor and combustor emissions monitoring as well as for monitoring of vehicle exhaust gases.

It is designed for stationary and continuous monitoring with high accuracy, sensitivity and stability.

All components which come in contact with sample are fully heated at 190 °C.

FID 22 NMHC analyser is used for stack gas measurement in:

- natural gas industry
- petrochemical industry
- pharmaceutical industry
- incineration plants
- plants for landfill and sewage gas recovery

### PERFORMANCE

Measuring range:	0 ... 10,000 mg C/m <sup>3</sup>
Repeatability:	+/- 1 % of range
Zero drift:	+/- 1 % in 24 h
Response time:	about 2 sec. (T <sub>90</sub> at sample gas inlet)
Warm-up time:	15 minutes

### YOUR BENEFITS AT A GLANCE

- complies with EN 12619 and EN 13526 standards for emission monitoring
- real dual chamber
- heating temperature about 190 °C
- Oxygen cross-sensitivity < 2 %
- Hydrogen consumption (fuel) about 70 ml/min; in case of use of Helium-Hydrogen-mixture about 400 ml/min
- combustion air via internal catalytic converter
- user-friendly 7" touch display and software
- graphic display of THC, CH<sub>4</sub> and NMHC concentration at once
- flow measurement (option) and pressure compensation function integrated
- single range - no switch between ranges
- internal datalogging and USB drive flash
- TCP/IP interface for easy datatransfer
- remote control function via Virtual Network Computing (software: FID 22 Master)

### PRECONDITIONS ON SITE

- installation place indoors and dust-free
- protection against wetness
- protection against percussions/vibrations
- power supply
- periphery (gas probe & a heated sampling gas line)
- operating gases



## BACKSIDE OF 19" RACK



## MEASURING PRINCIPLE

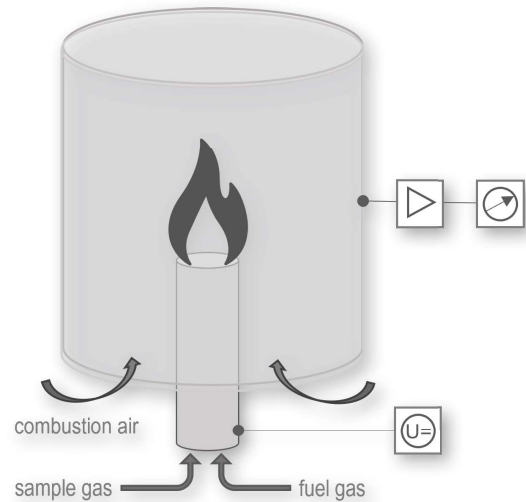

## OPTIONAL EQUIPMENT

- tablet for remote control, consisting of: internal router, Samsung tablet 10" with high-resolution touch display
- FID 22 line (heated sample gas line)
- FID 22 filter (heated pre-filter)
- FID 22 measuring gas probe

## OPERATION PRINCIPLE

The sample gas is extracted from the gas channel by means of a gas sampling probe via a heated pre-filter and fed to the analysis system via a heated sample gas line.

The FID 22 NMHC uses a flame ionization detector (FID) to measure the total hydrocarbons content (THC).

A second sample stream is fed with sample gas via a catalyst and the Methane concentration is measured ( $\text{CH}_4$ ).

The NMHC value is calculated from these two concentration values.

## TECHNICAL DATA

Protection class	IP40	
Dimension; weight:	482 x 420 x 133 mm (w x d x h); 15 kg	
Heating temperature:	Detector 190 °C (374 °F) External heating (optional) 60...250 °C (140 ... 480 °F) (adjustable)	
Gas requirements (consumption):	Fuel gas	$\text{H}_2$ 5.0 or He / $\text{H}_2$ (70 ml/min $\text{H}_2$ , 400 ml/min He / $\text{H}_2$ )
	Span gas	$\text{C}_3\text{H}_8$ / $\text{CH}_4$ (1 l/min)
	Zero gas	synthetic air
	Combustion air	conditioning using integrated catalytic converter
Ambient conditions:	Ambient temperature 5°C ... +45°C Relative air humidity max. 95 % (without condensate formation)	
Pressure compensation:	-150...+500 mbar	
Display:	7" TFT - Touch	
Remote control:	VNC / FID 22 Master	
Outputs:	Analogue 0...20 mA, 0...10 V (2 x; 4...20 mA with living zero point, burden 300 Ω) Digital Ethernet - RS232	
Power supply:	100...240 V, 50...60 Hz, 350 W	

## Multi component analyser system MCA 10 maritime

Extractive hot gas measuring system for emission measurement as well as for process control of exhaust treatment systems at sea shipping



- certified in compliance with MEPC.259(68), Doc. no.: 27975892/DNVGL
- tested according to DNV GL CG-0339, Cert. no.: TAA00002ZV
- ambient temperature in operation, vibration, electromagnetic compatibility: class A
- relative humidity, enclosure: class B

### APPLICATION

The analyser system MCA 10 maritime is certified in compliance with MEPC.259(68) for continuous monitoring of SO<sub>2</sub> and CO<sub>2</sub> in flue gas. It is based on the long-time proven, suitability tested multi component analyser MCA 10 HWIR.

In addition to SO<sub>2</sub> and CO<sub>2</sub> further measuring components, e.g. NO and NO<sub>2</sub>, can be detected.

The system MCA 10 maritime can be applied with a DNV certified probe and a heated measuring gas pipe.

### YOUR BENEFITS AT A GLANCE

- compact and robust measuring system with easy operating
- gas path continuously heated, no gas cooler needed
- appropriate for measurement preliminary and subsequent to exhaust treatment systems on ships
- measurement of up to 8 infrared components and oxygen
- internal measuring point switch-over possible
- correction of cross-sensitivity and air pressure
- low-maintenance technology with high measuring accuracy
- long-term stability by automatic zero point calibration
- automatic reference point calibration by adjusting filter (optional)
- low-maintenance fan instead of air conditioner
- remote control (optional) via Ethernet or UMTS router

MEASURING RANGES			
	Meas. range 1	Meas. range 2	Meas. range 3
CO:	0...60 ppm	0...240 ppm	0...4000 ppm
CO <sub>2</sub> :	0...12 vol.-% <sup>[1]</sup>	0...25 vol.-% <sup>[1]</sup>	0...50 vol.-%
NO:	0...60 ppm	0...300 ppm	0...2250 ppm
NO <sub>2</sub> :	0...25 ppm	0...250 ppm	-
NH <sub>3</sub> :	0...15 ppm	0...70 ppm	0...660 ppm
SO <sub>2</sub> :	0...30 ppm	0...100 ppm <sup>[1]</sup> / 0...250 ppm <sup>[1]</sup>	0...875 ppm
CH <sub>4</sub> :	0...70 ppm	0...700 ppm	-
H <sub>2</sub> O:	0...40 vol.-%	-	-
O <sub>2</sub> :	0...25 vol.-%	-	-

<sup>[1]</sup> certified in compliance with MEPC.259(68)  
Other components and measuring ranges on request.

### PRECONDITIONS ON SITE

- ambient conditions according to DNVGL-CG-0339
- power supply
- instrument air according to ISO 8573.1, class 2
- test gases for calibration
- appropriate gas sampling (certified sample probe, heated measuring gas pipe)

## SYSTEM



## PLC Interfaces:

- inputs for analogue and digital signals
- analogue outputs 4...20 mA
- digital outputs (e.g. failure, maintenance, maintenance requirement, measuring range switch over)
- Modbus RTU, Modbus TCP/IP, Profibus DP, Profinet

Direct connection for heated line (no gas cooler, no external pumps), therefore low maintenance requirement

Multi component analyser module MCA 10 HWIR

## TECHNICAL DATA

Analysing system:	steel sheet housing (IP54) with additional wall fixation and vibration dampers; 600 mm x 1510 mm x 500 mm (w x h x d), approx. 120 kg
Measuring methods:	<ul style="list-style-type: none"> <li>• bi-frequency measuring method (NO<sub>2</sub>, SO<sub>2</sub><sup>[1]</sup>, H<sub>2</sub>O, CO<sub>2</sub><sup>[1]</sup>)</li> <li>• gas filter correlation (CO, NO, NH<sub>3</sub>, CH<sub>4</sub>)</li> <li>• zirconium dioxide sensor (O<sub>2</sub>)</li> </ul>
Display / Operating:	15" touch panel, 1024 x 768 Pixel
Tested interfaces:	<ul style="list-style-type: none"> <li>• inputs for analogue and digital signals</li> <li>• analogue outputs 4...20 mA</li> <li>• digital outputs (e.g. failure, maintenance, maintenance requirement, measuring range switch-over)</li> <li>• Modbus RTU, Modbus TCP/IP, Profibus DP, Profinet</li> </ul>
Compressed-air connection:	pressure: 4...6 bar, consumption: ca. 1 m <sup>3</sup> /h
Gas conveyance:	via ejector; gas path continuously heated (standard 185 °C, higher temperatures on request)
Standardisation:	dry, wet
Sensitivity correction:	with test gas, once in 12 months (when using automatic calibration)
Calibration:	<ul style="list-style-type: none"> <li>• zero point: automatically with instrument air;</li> <li>• span point: with test gas, automatically by adjusting filter (optional)</li> </ul>
Power supply:	230 V or 400 V / 50 Hz, 4000 W (analyser cabinet, fan, probe) + 125 W/m measuring gas pipe; further options on request
Ambient conditions (acc. to DNVGL-CG-0339):	<ul style="list-style-type: none"> <li>• ambient temperature in operation: 5...45 °C (class A)</li> <li>• relative humidity: max. 95% (non-condensing) (class B)</li> <li>• vibration: class A</li> <li>• electromagnetic compatibility: class A</li> <li>• enclosure: class B</li> </ul>
Available system components (optional):	DNV certified probe, measuring gas pipe, switch-over between two measuring points (certified; response time for each measuring point: T <sub>90</sub> < 140 s)
<p><sup>[1]</sup> certified in compliance with MEPC.259(68) Special models are possible on request.</p>	

## Mobile multi component analyser MCA 14 m

Mobile measuring system for temporary emission measurement of pollutants in flue gas and for process control



### APPLICATION

The MCA 14 m measures the concentrations of up to twelve infrared gas components and evaluates them internally. Visualisation, operating and data logging are realised via the delivered software.

The unique characteristic is that instrument air supply is not necessary for its operation. The zero point setting is carried out with ambient air.

MEASURING RANGES			
	Meas. range 1	Meas. range 2	Meas. range 3
CO:	0...75 mg/m <sup>3</sup>	0...300 mg/m <sup>3</sup>	0...5000 mg/m <sup>3</sup>
CO <sub>2</sub> :	0...25 vol. %	0...50 vol. %	-
NO:	0...100 mg/m <sup>3</sup>	0...400 mg/m <sup>3</sup>	0...3000 mg/m <sup>3</sup>
NO <sub>2</sub> :	0...50 mg/m <sup>3</sup>	0...500 mg/m <sup>3</sup>	-
N <sub>2</sub> O:	0...50 mg/m <sup>3</sup>	0...3000 mg/m <sup>3</sup>	-
NH <sub>3</sub> :	0...10 mg/m <sup>3</sup>	0...50 mg/m <sup>3</sup>	0...500 mg/m <sup>3</sup>
SO <sub>2</sub> :	0...50 mg/m <sup>3</sup>	0...300 mg/m <sup>3</sup>	0...2500 mg/m <sup>3</sup>
CH <sub>4</sub> :	0...50 mg/m <sup>3</sup>	0...500 mg/m <sup>3</sup>	-
CH <sub>2</sub> O:	0...10 mg/m <sup>3</sup>	0...20 mg/m <sup>3</sup>	0...100 mg/m <sup>3</sup>
HCl:	0...15 mg/m <sup>3</sup>	0...90 mg/m <sup>3</sup>	0...5000 mg/m <sup>3</sup>
H <sub>2</sub> O:	0...40 vol. %	-	-
O <sub>2</sub> :	0...25 vol. %	-	-

*Other components and measuring ranges on request.*

### YOUR BENEFITS AT A GLANCE

- mobile hot gas analyser system in small format
- no instrument air necessary
- continuous, extractive measurement of up to twelve infrared components and oxygen
- field-proven components, modern photometer technology
- self-sustaining operation by pump supply
- long operation times, high reliability
- easy placement directly at the measuring point
- pre-calibrated → immediately deployable
- integrated zero gas provision with ambient air
- visualisation and operating via delivered software
- optionally integrated thermal printer or RS232 connection for data output

### PRECONDITIONS ON SITE

- installation place indoors and dust-free with protection against wetness and percussions/vibrations
- provision of non-contaminated ambient air for zero point setting
- power supply and PC/laptop/tablet\* with USB interface (resolution min. 1024 x 768 Pixel; Windows XP Professional upwards for installation of delivered user software)
- appropriate gas sampling

\* tablet as additional device available (option)

## SYSTEM DESIGN

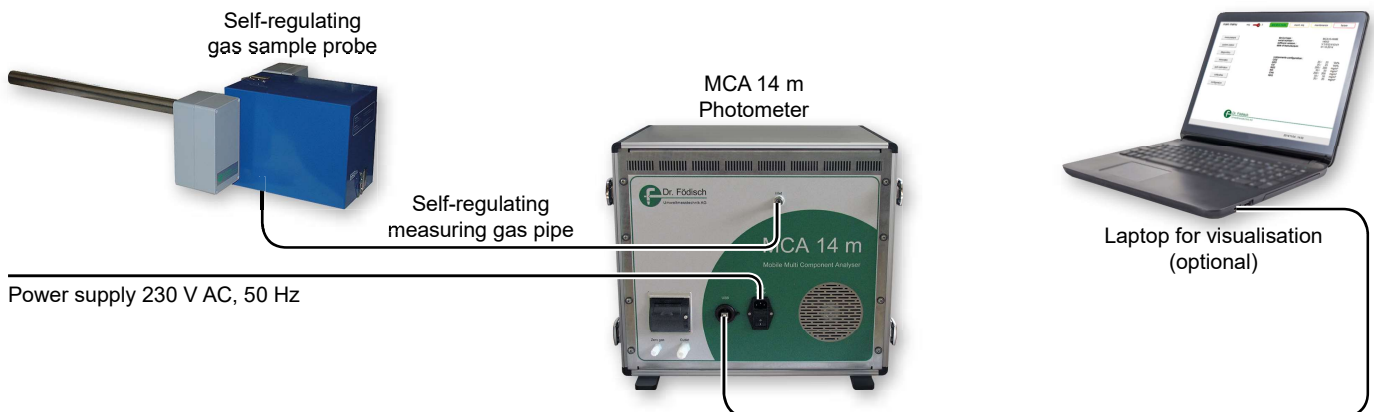

## TECHNICAL DATA

Housing:	mobile housing with carrying handles; IP54 (in case of closed housing cover) / IP31 (in case of opened housing cover); 536 mm x 453 mm x 430 mm (w x h x d), approx. 34 kg (depending on fitments)
Measuring methods:	<ul style="list-style-type: none"> <li>• bi-frequency measuring method (NO<sub>2</sub>, SO<sub>2</sub>, H<sub>2</sub>O, CO<sub>2</sub>)</li> <li>• gas filter correlation (CO, NO, HCl, NH<sub>3</sub>, N<sub>2</sub>O, CH<sub>4</sub>)</li> <li>• zirconium dioxide sensor (O<sub>2</sub>)</li> </ul>
Number of meas. components:	up to 12 infrared components (dependent on application) and oxygen
Accuracy:	< 2% of the respective measuring range
Ambient conditions:	operation: 0...45 °C (temperature stability max. ± 5 °C); storage: 5...35 °C (temperature stability max. 3 K/h); relative humidity: max. 90% (non-condensing)
Zero point correction:	automatical with ambient air
Sensitivity correction:	with test gas, once in 6 months (sensitivity tests as standard with a concentration of 80% of the measuring range)
Standardisation:	dry, wet
Heat-up phase:	ready for operation after approx. 90 min (at ambient temperature of approx. 20 °C)
Media temperature:	max. 200 °C
Display / Operating:	user software (MCA14m_HID.exe) via USB connection, language selectable by software (German, English, Chinese)
Data storage:	data logger function via tablet/PC
Data output:	output of measuring values and device configuration by integrated thermal printer or optionally via RS232 interface (Modbus)
Interfaces:	USB connection; optionally RS232 connection for data output
Power supply:	230 V AC, 50 Hz (optional: 115 V AC, 60 Hz), 510 W
Other functions:	gas path continuously heated (standard 200 °C, higher temperatures on request), cross-sensitivity correction, air pressure correction, gas conveyance by pump
<i>Special models are possible on request.</i>	

## Flame Ionisation Detector FID 22 m TOC

Portable Flame Ionisation Detector for monitoring of hydrocarbons in exhaust gases and ambient air



### APPLICATION

The FID 22 m TOC is a hydrocarbon analyser that can be used in the field or on site at the customer's location due to its compact and robust design.

It is used for continuous monitoring of the concentration of hydrocarbons in gases from industrial plants (emissions) or in ambient air (immissions).

The analyser works extractively. The sample gas is extracted from the gas channel by means of a gas sampling probe using a heated pre-filter and fed to the analysis system via a heated sample gas line.

During operation the whole gas path is heated to 190 °C (optional 300 °C).

The FID 22 m TOC is designed for:

- periodic measurements of emissions from stationary sources and stack gas testing
- leakage monitoring
- ambient air monitoring
- working place monitoring

### PERFORMANCE

Measuring range:	0 ... 100,000 mg C/m <sup>3</sup>
Repeatability:	+/- 1 % of range
Zero drift:	+/- 1 % in 24 h
Response time:	about 1 sec. (T <sub>90</sub> ; at sample gas inlet)
Warm-up time:	15 minutes

### YOUR BENEFITS AT A GLANCE

- certification according to EN 15267-3 QAL1 and MCerts in progress
- low Oxygen interference (< 2 %)
- Hydrogen consumption (fuel) about 30 ml/min
- graphic display of HC-concentration
- performing an automatic calibration (AutoCal)
- integrated catalytic converter for fuel gas processing, replacement of filling only every 5 - 7 years
- automatic pressure and sample gas flow control performing an automatic calibration (AutoCal)
- single range - no switch between ranges
- heated sample gas filter
- compensation of sensitivity using response factors
- short heating time (about 20 min)
- internal datalogging by USB flash drive
- user-friendly 7" touch display and software
- pyrolysis cleaning function for a self-cleaning procedure of the gas path and cell
- built in zero gas generator (option)
- device version with injector available

### PRECONDITIONS ON SITE

- dust-free measuring environment
- low vibration level
- power supply
- periphery (gas probe & heated sampling gas line)
- operating gases



## BACKSIDE OF DEVICE



## MEASURING PRINCIPLE

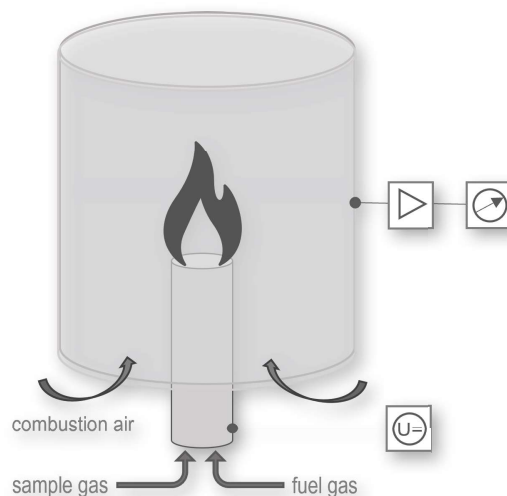

## OPTIONAL EQUIPMENT

- tablet for remote control, consisting of: internal router, Samsung tablet 10" with high-resolution touch display
- FID 22 line (heated sample gas line)
- FID 22 filter (heated pre-filter)
- FID 22 measuring gas probe

## OPERATION PRINCIPLE

The FID 22 TOC uses a flame ionization detector (FID) to measure hydrocarbons.

In the FID chamber a hydrogen flame burns in an electrical field and fed by high purity fuel gas as well as an absolutely hydrocarbon-free combustion air. The sample gas to be analyzed is also fed into this flame.

The hydrocarbons in the sample gas are "cracked" and the HC fragments are ionized. An ion current in the order of 10 - 14 A is generated in the electric field.

## TECHNICAL DATA

Protection class	IP40
Dimension; weight:	133 x 482 x 420 mm (w x h x d); 12 kg
Heating temperature:	detector 190 °C (optional 300 °C)
Gas requirements (consumption):	Fuel gas H <sub>2</sub> 5.0 (about 1.8 l/h) Zero and span gas N <sub>2</sub> and Propane (about 60 l/h) Combustion air ambient air, conditioning using integrated catalytic converter (standard), external combustion air generator (option)
Ambient conditions:	Ambient temperature 5°C ... +45°C (during application) Relative air humidity max. 95 % (without condensate formation)
Pressure compensation:	-150 mbar ...+500 mbar
Display:	7" TFT - Touch
Remote control:	VNC / FID 22 Master
Outputs:	Analogue 0 - 20 mA, 0 - 10 V (2 x ; with living zero point at 4 mA, burden 300 Ω) Digital Ethernet - RS232
Power supply:	115 / 230 V, 50-60 Hz, 350 W

## Flame Ionisation Detector FID 22 m NMHC

Portable Flame Ionisation Detector for monitoring of non-methane hydrocarbons, total hydrocarbon content and Methane in exhaust gases

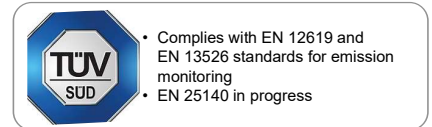

### APPLICATION

The FID 22 m NMHC Analyser measures the total hydrocarbon content (THC) as well as the Methane content and calculates the non-methane hydrocarbons concentration (NMHC).

The sample gas is extracted at the measuring point and passed through the analysis system.

This measuring method allows continuous monitoring of the emissions of organically bound carbon without major intervention in the system.

The range of industrial application - emission monitoring and process control - includes:

- monitoring of emissions of gas engines
- monitoring of exhausts of waste incineration plants
- monitoring of biological exhaust gas treatment plants (biofilter)

### PERFORMANCE

Repeatability:	+/- 1 % of range
Zero drift:	+/- 1 % in 24 h
Response time:	about 2 sec. ( $T_{90}$ )
Warm-up time:	15 minutes

### MEASURING RANGES

Smallest measuring range	0 ... 1 mg C/m <sup>3</sup>
Largest measuring range	0 ... 10,000 mg C/m <sup>3</sup>

### YOUR BENEFITS AT A GLANCE

- complies with EN 12619 & EN 13526 standards for emission monitoring (certification on EN 25140 in progress)
- real dual chamber device
- heating temperature about 190 °C
- Oxygen cross-sensitivity < 2 %
- Hydrogen consumption (fuel) about 70 ml/min; in case of use of Helium-Hydrogen-mixture about 400 ml/min
- combustion air via internal catalytic converter
- flow measurement (option) and pressure compensation function integrated
- single range - no switch between ranges
- user-friendly 7" touch display and software
- graphic display of THC, CH<sub>4</sub> and NMHC concentration
- datalogging by USB flash drive
- gas cylinders with suitcase available

### PRECONDITIONS ON SITE

- dust-free measuring environment
- low vibration level
- power supply
- periphery (gas probe & heated sampling gas line)
- operating gases

## BACKSIDE OF DEVICE



## MEASURING PRINCIPLE

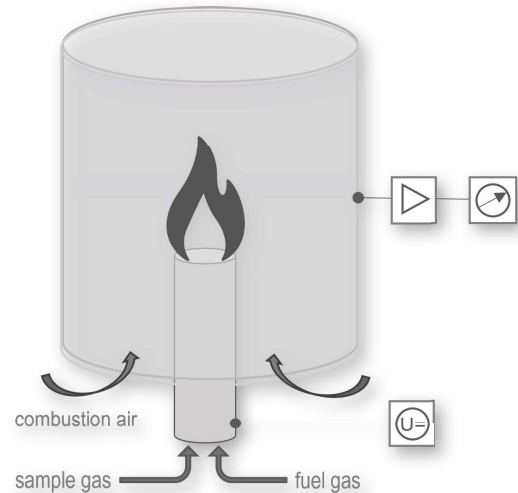

## OPTIONAL EQUIPMENT

- equipment transport case for FID 22 m
- tablet for remote control
- gas cylinders with suitcase
- FID 22 measuring gas probe
- FID 22 line (heated sample gas line; length: 3 m, 5 m or 10 m)
- FID 22 filter (heated pre-filter)

## OPERATION PRINCIPLE

The sample gas is extracted from the stack by means of a gas sampling probe via a heated pre-filter and fed to the analysis system via a heated sample gas line.

The FID 22 m NMHC uses a flame ionization detector (FID) to measure the total hydrocarbons content.

A second sample stream is fed with sample gas via a catalytic converter and the Methane concentration is measured ( $\text{CH}_4$ ).

The NMHC value is calculated from these two concentration values.

## TECHNICAL DATA

Protection class	IP42	
Dimension; weight:	425 x 412 x 262 mm (w x d x h); 12 kg	
Heating temperature:	Detector 190 °C (374 °F) External heating 60...250 °C (140 ... 480 °F) (adjustable)	
Gas requirements (consumption):	Fuel gas	$\text{H}_2$ 5.0 or He / $\text{H}_2$ (70 ml/min $\text{H}_2$ , 400 ml/min He / $\text{H}_2$ )
	Span gas	$\text{C}_3\text{H}_8$ / $\text{CH}_4$ (1 l/min)
	Zero gas	synthetic air (1 l/min)
	Combustion air	ambient air, conditioning using integrated catalytic converter
Ambient conditions:	Ambient temperature 5°C...+45°C Relative air humidity max. 95 % (without condensate formation)	
Pressure compensation:	-150 mbar ...+500 mbar	
Display:	7" TFT - Touch	
Remote control:	VNC / FID 22 Master	
Outputs:	Analogue 0...20 mA, 0...10V (2 x; 4...20 mA with living zero point, burden 300 Ω) Digital Ethernet - RS232	
Power supply:	115 / 230 V, 50-60 Hz, 350 W	

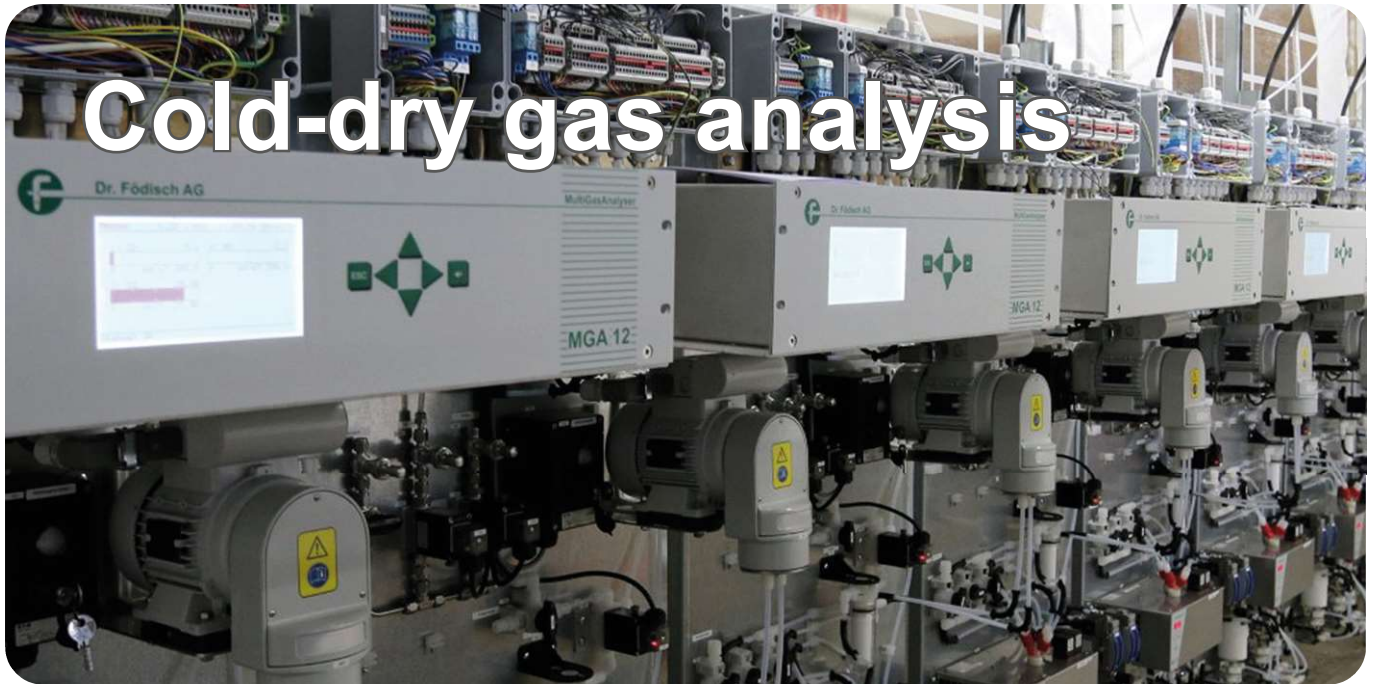

Cold-dry measurement is – same like hot-wet measurement – based on the extractive working principle. A partial flow of gaseous components is withdrawn by a sampling probe and sampling pipe and led to the analysis cabinet. A gas conditioning inside the cabinet cools the sample gas to 5 °C to dry the gas for analysis. Depending on the pollutants various analyser modules and measuring principles can be applied (UV spectrometer, NDIR photometer, electrochemical cell, paramagnetic or thermal conductivity sensor). Based on customer requirements the most efficient method for each component is chosen.

Apart from CEMS installations being in compliance with EN 15267-3 (QAL1), it is possible to use the analyser MGA 12 for process measurements, e.g. for  $\Delta\text{CO}$ - or  $\Delta\text{NO}$ -measurements.

The cold-dry gas analysers are widely used amongst others in:

- power plants
- biomass boilers
- coal mills
- coke plants
- pulp and paper industry
- chemical industry

#### Scheme of infrared absorption

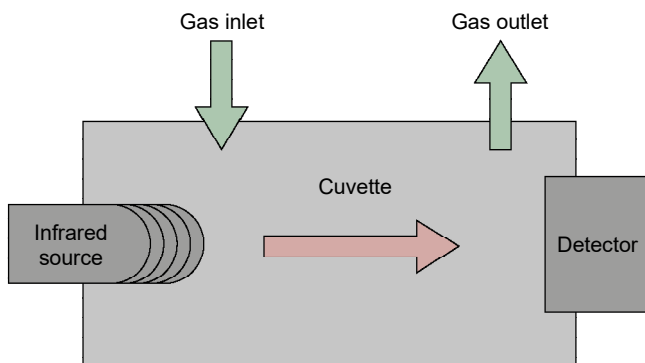

#### Scheme of electrochemical cell

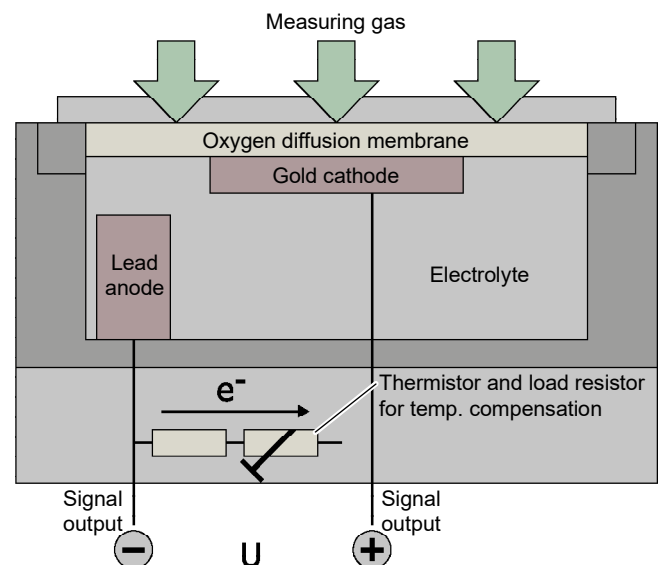

## Cold-dry gas analysers by comparison

	MGA 12	MGA 12 EX	UVA 17 CD	MGA 20
<b>Field of application</b>				
Process measurement	●	●	●	●
TUV-approved CEMS for combustion plants	● <sup>[1]</sup>			● <sup>[4]</sup>
Application in potentially explosive atmospheres (ATEX)		●		
Mobile use	● <sup>[2]</sup>			
<b>Device characteristics</b>				
Measuring principle:				
• Infrared photometer	●	●		●
• UV spectrometer			●	
• Electrochemical cell (O <sub>2</sub> , H <sub>2</sub> S)	●	●	●	opt.
• Paramagnetic sensor (O <sub>2</sub> )	●	●		opt.
• Zirconium dioxid sensor (O <sub>2</sub> )				●
• Thermal conductivity sensor (H <sub>2</sub> )	●	●		
Data transfer:				
• Analogue outputs 4...20 mA	●	●	●	●
• Digital outputs (e.g. limit value 1/2, maintenance request, maintenance, failure)	●	●	●	●
• RS232 / Modbus RTU	●	●	●	●
• Remote access	●	●	●	●
Other device features:				
• Integrated display/operating unit	●	●	●	●
• Detached display/operating unit				
<b>Measuring components</b>				
Max. quantity of simultaneously detectable components	8	5	12	8
Max. quantity of simultaneously output components (for analogue outputs)	5	5	8	8
CO Carbon Monoxide	●	●		●
CO <sub>2</sub> Carbon Dioxide	●	●		●
NO Nitrogen Monoxide	●	●	●	●
NO <sub>2</sub> Nitrogen Dioxide	● <sup>[3]</sup>	●	●	●
N <sub>2</sub> O Nitrous Oxide	●	●		●
SO <sub>2</sub> Sulphur Dioxide	●	●	●	●
CH <sub>4</sub> Methane	● <sup>[3]</sup>	●		●
CH <sub>2</sub> O Formaldehyde			●	
H <sub>2</sub> Hydrogen	● <sup>[3]</sup>	● <sup>[3]</sup>		
H <sub>2</sub> S Hydrogen Sulfide	● <sup>[3]</sup>	●	●	
Cl <sub>2</sub> Chlorine			●	
O <sub>2</sub> Oxygen	●	●	●	●
<sup>[1]</sup> suitability tested according to EN 15267-3, certified in compliance with QAL1 and MCERTS Performance Standards <sup>[2]</sup> on request as special model <sup>[3]</sup> not part of the suitability test <sup>[4]</sup> certification in progress				

Cold-dry gas analysis



## Multi gas analyser MGA 12

Cold gas measuring system for continuous emission measurement of pollutants in flue gas and for process control



### APPLICATION

In the MGA 12 four independent, selectively working measuring methods apply: infrared absorption (NDIR), electrochemical cell and paramagnetic measuring method as well as thermal conductivity sensor.

MEASURING RANGES		
	Meas. range 1	Meas. range 2
CO:	0...125 mg/m <sup>3</sup> (0...100 ppm)	0...1,000 mg/m <sup>3</sup> (0...800 ppm)
CO <sub>2</sub> :	0...20 vol. %	-
NO:	0...300 mg/m <sup>3</sup> (0...225 ppm)	0...1,000 mg/m <sup>3</sup> (0...750 ppm)
NO <sub>2</sub> <sup>[1]</sup> :	0...200 mg/m <sup>3</sup> (0...95 ppm)	0...1,000 mg/m <sup>3</sup> (0...485 ppm)
N <sub>2</sub> O <sup>[1]</sup> :	0...300 mg/m <sup>3</sup> (0...155 ppm)	0...1,000 mg/m <sup>3</sup> (0...510 ppm)
SO <sub>2</sub> :	0...200 mg/m <sup>3</sup> (0...70 ppm)	0...1,000 mg/m <sup>3</sup> (0...350 ppm)
CH <sub>4</sub> <sup>[1]</sup> :	0...300 mg/m <sup>3</sup> (0...420 ppm)	0...1,000 mg/m <sup>3</sup> (0...1,400 ppm)
H <sub>2</sub> <sup>[1][2]</sup> :	0...5 vol. %	0...100 vol. %
H <sub>2</sub> S <sup>[1][3]</sup> :	0...75 mg/m <sup>3</sup> (0...50 ppm)	-
O <sub>2</sub> <sup>[3][4]</sup> :	0...25 vol. %	-

<sup>[1]</sup> not part of the suitability test  
<sup>[2]</sup> measurement via thermal conductivity sensor <sup>[1]</sup>  
<sup>[3]</sup> measurement via electrochemical cell  
<sup>[4]</sup> measurement via paramagnetic sensor <sup>[1]</sup>  
 Other components and measuring ranges on request.

### YOUR BENEFITS AT A GLANCE

- simultaneous measurement of up to eight gas components with limit value signalling and measuring range change-over
- two separated gas paths possible
- local diagnosis of the system state
- display of bar diagram for every component
- flow control as well as display of flow rate
- reduced cross-sensitivities by internal spectral filter
- internal monitoring for condensate ingress with switch contact for pump switch-off
- control of a back-purging probe (interval and pulse time)
- control of zero point drift
- low maintenance requirement

### PRECONDITIONS ON SITE

- ambient temperature: 5...30 °C (with air conditioner 5...45 °C)
- installation place indoors and dust-free
- protection against wetness
- protection against percussions/vibrations



## OPTICAL BENCH

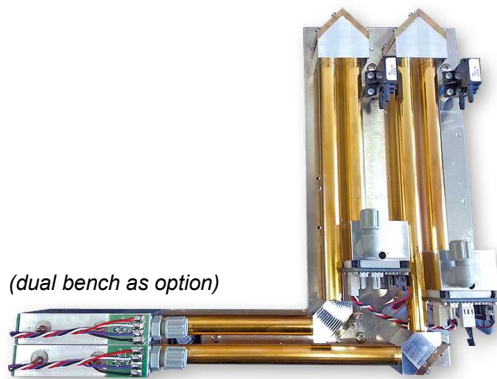

(dual bench as option)

## PHOTOMETER

- consisting of: emitting module, measuring cells, reflector modules, 4-channel pyrodetector with pre-amplifier electronics, detector module
- free-selectable length of the measuring path with direction changes: 50 mm to 700 mm
- spectral range: 1  $\mu\text{m}$  to 9  $\mu\text{m}$
- no mechanically moved parts
- power supply: 5 V DC
- power consumption in operation: approx. 20 W (at ambient temperature of 30 °C)

## TECHNICAL DATA

Analyser:	robust housing with compact 19" format 3RU, IP40; 483 mm x 133 mm x 350 mm (w x h x d), approx. 11 kg
Analyser cabinet:	800 mm x 2100 mm x 600 mm (w x h x d), approx. 170 kg
Measuring methods:	<ul style="list-style-type: none"> <li>• infrared absorption (CO, CO<sub>2</sub>, SO<sub>2</sub>, NO, NO<sub>2</sub> <sup>[1]</sup>, CH<sub>4</sub> <sup>[1]</sup>, H<sub>2</sub>O <sup>[1]</sup>)</li> <li>• electrochemical cell (O<sub>2</sub>, H<sub>2</sub>S <sup>[1]</sup>)</li> <li>• paramagnetic measuring method <sup>[1]</sup> (optional for O<sub>2</sub>)</li> <li>• thermal conductivity sensor <sup>[1]</sup> (H<sub>2</sub>)</li> </ul>
Accuracy:	< 2% of the respective measuring range
Sensitivity correction:	manual, with test gas; optional: automatic
Response time:	T <sub>90</sub> < 180 s (depending on plant and chosen component)
Ambient conditions:	5...30 °C (with air conditioning unit 5...45 °C); relative humidity: max. 90% (non-condensing)
Display / Operating:	graphic display (LCD), 240 x 128 Pixel, background-lighted; menu-driven operating; display possibility in mg/m <sup>3</sup> , ppm and vol. %; languages (factory-set): German, English, French, Polish; membrane keyboard
Analogue outputs:	5 active analogue outputs, 4...20 mA, potential-free, burden max. 500 Ohm
Digital inputs:	8 inputs (optocoupler; e.g. for sample probe, measuring gas pipe, gas cooling unit)
Digital outputs:	16 outputs, potential-free, 24 V DC with max. 0.4 A (max. 10 W); amongst others: <ul style="list-style-type: none"> <li>• output signals for failure, maintenance, maintenance request, limit values, measuring range change-over, Autocal</li> <li>• control of automatic probe back-purging</li> <li>• internal humidity monitor for function „Pump off“</li> <li>• control of metering of phosphoric acid (H<sub>3</sub>PO<sub>4</sub>)</li> </ul>
Service interface RS232:	for remote software, compatible for all Windows operating systems (XP or higher version): <ul style="list-style-type: none"> <li>• visualisation of all data by intuitive user surface</li> <li>• data storage on PC in TXT format</li> <li>• loading/saving of all relevant configuration data</li> </ul>
Power supply:	110 V AC, 230 V AC / 50-60 Hz, 40 W
Other functions:	<ul style="list-style-type: none"> <li>• standard: thermostatted infrared photometer; automatic zero point correction with ambient air; internal air pressure correction</li> <li>• optional: two separated gas paths; analyser-specific PC user software for visualisation, (remote) control and recording of data via interface RS232</li> </ul>
<sup>[1]</sup> not part of the suitability test Special models are possible on request.	

## Multi gas analyser MGA 12 EX

Cold gas measuring system for continuous emission measurement of pollutants in potentially explosive atmospheres



- approved for Ex II 2G Ex db IIB+H2 T5 Gb
- protective principle Ex d
- explosive gases can be passed through in a closed loop
- application in Ex-Zone 1 and 2

### APPLICATION

The multi gas analyser MGA 12 EX can be applied as single oxygen measuring device in potentially explosive atmospheres.

For oxygen measurement two different measuring methods are applicable. These are carried out by electrochemical cell respectively by paramagnetic sensor.

### YOUR BENEFITS AT A GLANCE

- certified for use in potentially explosive areas Ex-Zone 1 and 2
- protective principle Ex db
- pressure-resistant gas path up to 3 bar
- explosive gases can be passed through in a closed loop
- simultaneous measurement of up to five gas components
- reduced cross-sensitivities by internal spectral filter
- integrated zero gas valve for zero point correction
- all gas-contacting elements are made of metal

### MEASURING RANGES

	Meas. range 1	Meas. range 2
CO:	0...125 mg/m <sup>3</sup> (0...100 ppm)	0...1,000 mg/m <sup>3</sup> (0...800 ppm)
CO <sub>2</sub> :	0...20 vol. %	-
NO:	0...300 mg/m <sup>3</sup> (0...225 ppm)	0...1,000 mg/m <sup>3</sup> (0...750 ppm)
NO <sub>2</sub> :	0...200 mg/m <sup>3</sup> (0...95 ppm)	0...1,000 mg/m <sup>3</sup> (0...485 ppm)
N <sub>2</sub> O:	0...300 mg/m <sup>3</sup> (0...155 ppm)	0...1,000 mg/m <sup>3</sup> (0...510 ppm)
SO <sub>2</sub> :	0...200 mg/m <sup>3</sup> (0...70 ppm)	0...1,000 mg/m <sup>3</sup> (0...350 ppm)
CH <sub>4</sub> :	0...300 mg/m <sup>3</sup> (0...420 ppm)	0...1,000 mg/m <sup>3</sup> (0...1400 ppm)
H <sub>2</sub> <sup>[1]</sup> :	0...5 vol. %	0...100 vol. %
H <sub>2</sub> S <sup>[2]</sup> :	0...75 mg/m <sup>3</sup> (0...50 ppm)	-
O <sub>2</sub> <sup>[2][3]</sup> :	0...25 vol. %	-

<sup>[1]</sup> measurement via thermal conductivity sensor <sup>[1]</sup>  
<sup>[2]</sup> measurement via electrochemical cell  
<sup>[3]</sup> measurement via paramagnetic sensor <sup>[1]</sup>  
 Other components and measuring ranges on request.

## DESIGN & APPLICATION

The MGA 12 EX consists of a robust housing for application in potentially explosive atmospheres (Ex-zone: 1 and 2). In the interior of the housing the measuring technology of the analyser with the optical bench, the power supply unit and the signal processing is placed.

At the analysis of gas concentrations by the MGA 12 EX four different measuring methods are applied: infrared absorption, electrochemical cell, paramagnetic measuring method (optional), thermal conductivity sensor.

## USE IN POTENTIALLY EXPLOSIVE AREAS

- flameproof enclosure
- application in Ex-Zone 1 and 2

## PRECONDITIONS ON SITE

- ambient temperature: -20...+40 °C
- protection against percussions/vibrations
- appropriate gas sampling and conditioning

TECHNICAL DATA	
Housing:	robust housing, IP66; thermostatted infrared photometer (optical bench); 400 mm x 600 mm x 290 mm (w x h x d); approx. 40 kg (with paramagnetic sensor 75 kg)
ATEX-certification:	Ex II 2G Ex db IIB+H2 T5 Gb
Measuring methods:	<ul style="list-style-type: none"> <li>• infrared absorption (CO, CO<sub>2</sub>, SO<sub>2</sub>, NO, NO<sub>2</sub>, CH<sub>4</sub>, H<sub>2</sub>O)</li> <li>• electrochemical cell (O<sub>2</sub>, H<sub>2</sub>S)</li> <li>• paramagnetic measuring method (O<sub>2</sub>)</li> <li>• thermal conductivity sensor (H<sub>2</sub>)</li> </ul>
Accuracy:	< 2% of the respective measuring range
Response time:	T <sub>90</sub> < 180 s (depending on plant and chosen component)
Ambient conditions:	-20...+40 °C; relative humidity: max. 90% (non-condensing)
Zero point correction:	automatic by integrated zero gas valve, with ambient air
Sensitivity correction:	manual, with test gas
Air pressure correction:	internal pressure sensor for real-time pressure compensation of measuring values
Gas inputs/outputs:	measuring gas input, zero gas input, exhaust output, air breather; respectively with flame barrier, 6 mm Swagelok
Display / Operating:	graphic display (LCD), 240 x 128 Pixel, background-lighted; menu-driven operating; display possibility in mg/m <sup>3</sup> , ppm and vol. %; languages (factory-set): German, English, French, Polish; 6 operating keys
Analogue outputs:	4 active analogue outputs, 4...20 mA, potential-free, burden max. 500 Ohm
Digital outputs:	4 digital outputs, potential-free, 24 V DC with max. 0.4 A (max. 10 W) for failure, maintenance, maintenance request and zero point setting
Service interface:	RS232 and remote software for maintenance and diagnostic purpose
Power supply:	230 V AC / 50-60 Hz, 40 W (max. 90 W)
Options:	<ul style="list-style-type: none"> <li>• paramagnetic oxygen sensor for measurement of O<sub>2</sub> (not available for pressure-resistant model, standard pressure up to max. 500 mbar)</li> <li>• thermal conductivity sensor for measurement of H<sub>2</sub> (not available for pressure-resistant model, standard pressure up to max. 500 mbar)</li> <li>• pressure-resistant model: pressure resistance of the measuring gas path up to max. 3 bar (not available in connection with paramagnetic oxygen sensor or thermal conductivity sensor)</li> <li>• digital inputs (optocoupler; e.g. for air breather, measuring gas pipe, gas cooling unit)</li> </ul>
<i>Special models are possible on request.</i>	

## Cold gas UV analyser UVA 17 CD

Cold-dry spectrometer-based gas analyser for measurement of pollutants in flue gas with low concentrations and for process control



### APPLICATION

The UV analyser UVA 17 CD can be used for monitoring of e.g. NO, NO<sub>2</sub>, SO<sub>2</sub> and O<sub>2</sub> in incineration plants as well as for process measurements in the chemical and pharmaceutical industry.

This analyser is based on a spectrometer and measures all UV absorbing gas components. The applied Xenon flash light is characterised by a 2 to 3 times higher lifetime compared to other light sources.

The oxygen measurement is carried out optionally by a paramagnetic oxygen sensor or an electrochemical cell.

A small PC with 7" colour display and an app-based menu allow an intuitive operation on site as well as remotely.

### YOUR BENEFITS AT A GLANCE

- compact design
- long-term stable signal
- user-friendly touch display
- extension of measuring components without additional hardware possible
- remote access

### PRECONDITIONS ON SITE

- installation place indoors and dust-free
- protection against wetness
- protection against percussions/vibrations
- appropriate gas sampling and conditioning

#### LOWEST MEASURING RANGES

Component	Measuring range
NO:	0...50 mg/m <sup>3</sup>
NO <sub>2</sub> :	0...100 mg/m <sup>3</sup>
SO <sub>2</sub> :	0...50 mg/m <sup>3</sup>
O <sub>2</sub> :	0...25 vol. %
<i>Other components (e.g. CH<sub>2</sub>O, H<sub>2</sub>S, Cl<sub>2</sub>) and measuring ranges on request.</i>	

**SCHEMATIC DESIGN**

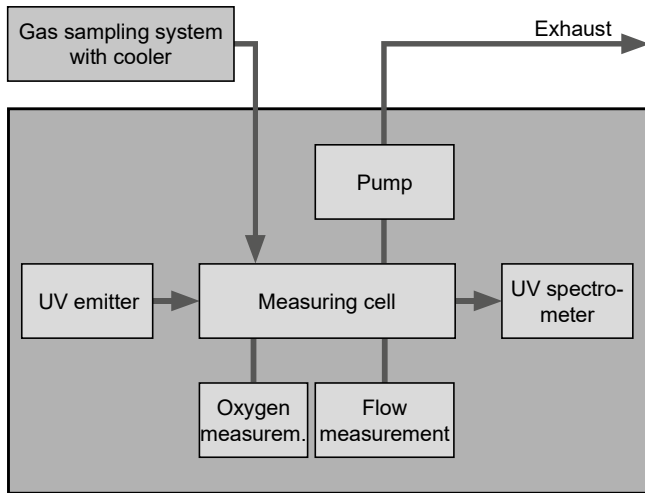

**FUNCTION**

The function of the UV analyser is based on the measurement of an integrated spectrometer in the spectral range of ultraviolet radiation of 180 to 400 nm. Fundamentally, the device is composed of light source, measuring cell and spectrometer which are interconnected via the optical path. The emitted radiation is absorbed partly by the process gas in the measuring cell and detected by a spectrometer afterwards. By using a chemometric model the gas component as well as the concentration can be determined.

Because of the modular design, there is the possibility for application of different spectrometers for adaptation to variable requirements.

**TECHNICAL DATA**

Housing:	robust housing with compact 19" format, IP40; 483 mm x 133 mm x 350 mm (w x h x d), approx. 12 kg
Measuring methods:	<ul style="list-style-type: none"> <li>• spectrometer 180-400 nm (NO<sub>2</sub>, SO<sub>2</sub>, NO, CH<sub>2</sub>O, H<sub>2</sub>S, Cl<sub>2</sub>)</li> <li>• electrochemical cell (optional for O<sub>2</sub>)</li> <li>• paramagnetic measuring method (optional for O<sub>2</sub>)</li> </ul>
Number of meas. components:	up to 12 components (dependent on application) and oxygen
Accuracy of spectrometer components:	< 2% of the respective measuring range
Paramagnetic oxygen sensor:	<ul style="list-style-type: none"> <li>• warm-up time: &lt; 1 h (at 20 °C ambient temperature)</li> <li>• zero point drift: &lt; ± 0.1% O<sub>2</sub> / week (possibly higher at first commissioning or after longer storage)</li> <li>• temperature influence:                             <ul style="list-style-type: none"> <li>- at zero point setting: &lt; ± 0.05% O<sub>2</sub> / °C</li> <li>- at reference point setting: &lt; ± 0.2% of meas. value / °C</li> </ul> </li> </ul>
Ambient conditions:	5...40 °C (temperature stability max. 5 K/h); humidity: max. 90% (non-condensing)
Optical bench:	<ul style="list-style-type: none"> <li>• path length of measuring cell: adjustable, 730 mm</li> <li>• particle filter: 2 µm</li> </ul>
Zero point setting:	automatically with ambient air
Measuring gas conveyance:	via internal pump: <ul style="list-style-type: none"> <li>• flow rate: max. 2.6 l/min</li> <li>• pressure: max. 1 bar</li> <li>• vacuum: max. 350 mbar</li> </ul>
Display / Operating:	7" touch display, 800 x 480 Pixel, status messages for failure, maintenance and maintenance request; Language selection: German, English, French, Chinese
Data storage:	data logger function
Interfaces:	RS232 (Modbus)
Inputs/outputs:	<ul style="list-style-type: none"> <li>• 8 analogue outputs, 4...20 mA, potential-free, burden max. 500 Ω</li> <li>• 14 digital inputs (optocoupler), max. 30 V</li> <li>• 16 digital outputs, potential-free, max. 60 V, 500 mA</li> </ul>
Remote control:	VNC, remote control via PC
Power supply:	110-250 V AC / 50-60 Hz, 50 W
Other functions:	integrated flow measurement
<i>Special models are possible on request.</i>	

Cold-dry gas analysis

## Multi gas analyser MGA 20

Cold gas analyser for measurement of pollutants in flue gas and for process control using IR-technology



• QAL1 certification according  
DIN EN 15267-1 (2009),  
DIN EN 15267-2 (2009),  
DIN EN 15267-3 (2008)  
In progress



### FUNCTION

A high-precision infrared photometer is used to determine the concentration of up to 8 gas components by means of infrared absorption.

Furthermore an electrochemical cell, zirconium dioxide sensors or paramagnetic sensor can be configured for oxygen measurement.

The analyser MGA 20 includes a high precision optical bench (infrared photometer) consisting mainly of an IR light source with chopper wheel, a measuring cell, a motordriven filter wheel and a detector.

MEASURING RANGES *		
	Meas. range 1	Meas. range 2
CO:	0...75 mg/m <sup>3</sup>	0...5,000 mg/m <sup>3</sup>
CO <sub>2</sub> :	0...25 vol. %	0...50 vol. %
NO:	0...50 mg/m <sup>3</sup>	0...3,000 mg/m <sup>3</sup>
NO <sub>2</sub> :	0...50 mg/m <sup>3</sup>	0...1,000 mg/m <sup>3</sup>
N <sub>2</sub> O:	0...50 mg/m <sup>3</sup>	0...2,000 mg/m <sup>3</sup>
NO <sub>x</sub>	0...80 mg/m <sup>3</sup>	0...3,000 mg/m <sup>3</sup>
SO <sub>2</sub> :	0...45 mg/m <sup>3</sup>	0...2,000 mg/m <sup>3</sup>
CH <sub>4</sub> :	0...50 mg/m <sup>3</sup>	0...1,500 mg/m <sup>3</sup>
O <sub>2</sub> :	0...25 vol. %	-
* suitability test in progress		

### YOUR BENEFITS AT A GLANCE

- 7" touch colour display and an app-based menu
- automatic zero point setting by means of ambient air; no need of compressed air
- Filtercal technology for reference point adjustment; without gas consumption
- high sensitivity due to optical path length
- remote access
- internal pump (external pump on request)

### PRECONDITIONS ON SITE

- ambient temperature: 5...40 °C (with air conditioner 5...45°C)
- installation place indoors and dust-free
- protection against wetness
- protection against percussions/vibrations



CEMS USING MGA 20



OPTICAL BENCH

- includes a broadband infrared (IR) emitter with chopper wheel, measuring cell with zirconium oxide probe, detector unit with pyroelectric broadband detector and filter wheel, preamplifier and evaluation electronics
- constantly temperature regulated at 60 °C
- length of measuring path with direction changes: 7,200 mm
- spectral range: 2 µm to 12 µm

TECHNICAL DATA

Analysers:	robust housing with compact 19" format 3 RU, IP40; 483 mm x 133 mm x 350 mm (w x h x d)
Measuring methods:	<ul style="list-style-type: none"> <li>• bi-frequency measuring method (NO<sub>2</sub>, SO<sub>2</sub>, CO<sub>2</sub>)</li> <li>• gas filter correlation (CO, NO, N<sub>2</sub>O, CH<sub>4</sub>)</li> <li>• zirconium dioxide sensor (O<sub>2</sub>)</li> <li>• electrochemical cell (optional for O<sub>2</sub>)</li> <li>• paramagnetic measuring method (optional for O<sub>2</sub>)</li> </ul>
Accuracy:	< 2% of the respective measuring range
Sensitivity correction:	manual, with test gas; optional: automatic
Response time:	T <sub>90</sub> < 180 s (depending on plant and chosen component)
Ambient conditions:	5...40 °C; relative humidity: max. 90% (non-condensing)
Display / Operating:	7" capacitive touch color display, with intuitive menu navigation display possibility in mg/m <sup>3</sup> , ppm and vol. %; languages (factory-set): German, English, French, Chinese
Analogue outputs:	8 active analogue outputs, 4...20 mA, potential-free, burden max. 500 Ohm
Digital inputs:	14 inputs (optocoupler; e.g. for error signal, sample probe, measuring gas pipe, gas cooling unit)
Digital outputs:	16 outputs, potential-free, 24 V DC with max. 0.4 A (max. 10 W); amongst others: <ul style="list-style-type: none"> <li>• output signals for failure, maintenance, maintenance request, limit values, measuring range change-over, Autocal</li> <li>• control of automatic probe back-purging</li> <li>• control of metering</li> <li>• control cabinet air conditioning and cabinet fan</li> </ul>
Interfaces:	<ul style="list-style-type: none"> <li>• RS232 (Modbus)</li> <li>• RJ45 (Remote access Ethernet/VNC), RJ45 (Modbus TCP/IP), RJ45 (Service Interface)</li> <li>• USB Typ A (USB Stick data exchange), USB Typ B (Service Interface)</li> </ul>
Power supply:	110...230 V AC / 50-60 Hz, 250 W
Other functions:	<ul style="list-style-type: none"> <li>• standard: temperature regulated infrared photometer; automatic zero point correction with ambient air</li> <li>• data logging function</li> <li>• visualization using the display, extensive visualization possibilities and diagnostic options</li> </ul>

Cold-dry gas analysis

# Oxygen measurement



Quick and exact oxygen measuring values are necessary for optimisation of combustion processes and emission monitoring. The oxygen analysers of Dr. Födisch Umweltmesstechnik AG are used for the oxygen concentration measurement in flue and process

gases. The oxygen can be measured by a zirconium dioxide sensor on in-situ-basis or extractively. In this case electrochemical cells or paramagnetic sensors are applied.

Scheme of paramagnetic measuring cell

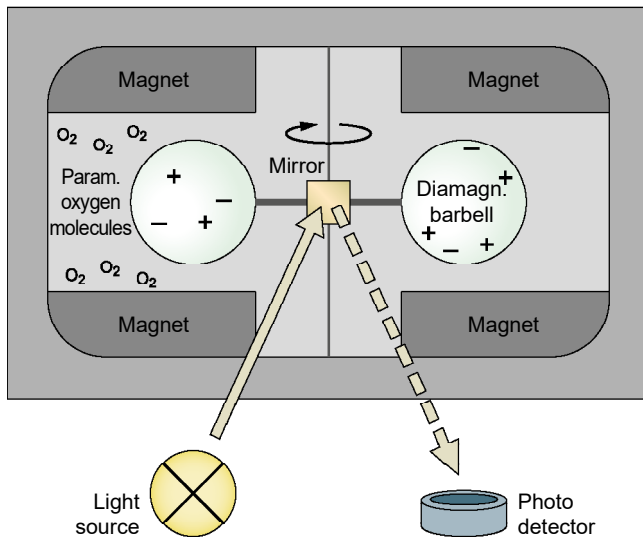

Scheme of zirconium dioxide sensor

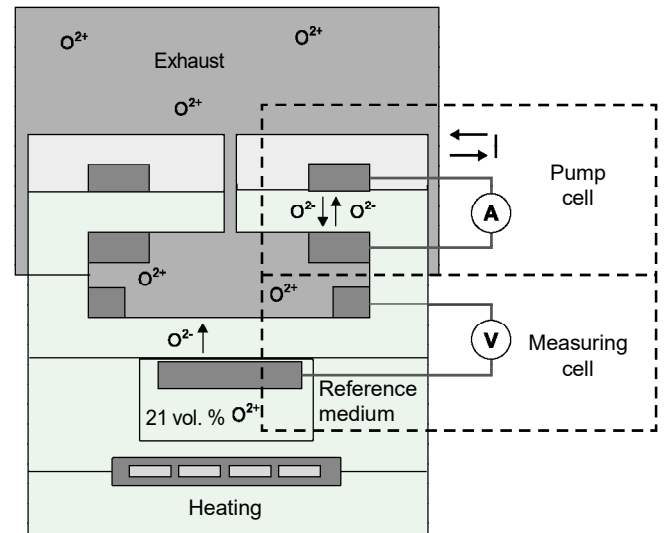

## Oxygen measuring devices by comparison

	OMD 14	MGA 12	MGA 12 EX	MGA 20
<b>Field of application</b>				
Process measurement	●	●	●	●
Application in potentially explosive atmospheres (ATEX)			●	
Exhaust conditions:				
• Corrosive gases	● <sup>[1]</sup>	●	●	
• Media temperature over 350 °C		●	●	
<b>Device characteristics</b>				
Measuring principle:				
• Electrochemical cell		●	●	●
• Paramagnetic sensor		●	●	●
• Zirconium dioxide sensor (O <sub>2</sub> )	●			●
Measuring arrangement:				
• In-situ	●			
• Extractive		●	●	●
• Integrated display/operating unit	●	●	●	●
Data transfer:				
• Modbus TCP/IP / RTU				●
• Remote access		●	●	●
Other device features:				
• External gas conditioning not necessary	●			
<b>Measuring components</b>				
Oxygen	●	●	●	●
Temperature	●			
IR components		●	●	●
<sup>[1]</sup> on request as special model				

Oxygen measurement

### Oxygen measuring device OMD 14

In-situ measuring device for continuous measurement of the concentration of free oxygen in flue gases and process gases



#### APPLICATION

The oxygen measuring device OMD 14 is used for the measurement of the oxygen concentration in flue gases and process gases. It is a compact system with integrated control unit. The probe length can be adapted to the channel dimensions.

Optionally there is the possibility to measure the humidity content ( $H_2O$ ) or to include a signal for an integrated temperature measurement (PT100).

#### YOUR BENEFITS AT A GLANCE

- compact device consisting of probe and operating unit → easy installation
- integrated graphic display for ease of operation
- display of  $O_2$  (and optionally  $H_2O$ ) in vol. %
- very low maintenance requirement
- easy manual calibration with test gases in separate adjustment device
- extremely low operational costs
- different probe lengths possible

#### INSTALLATION EXAMPLE

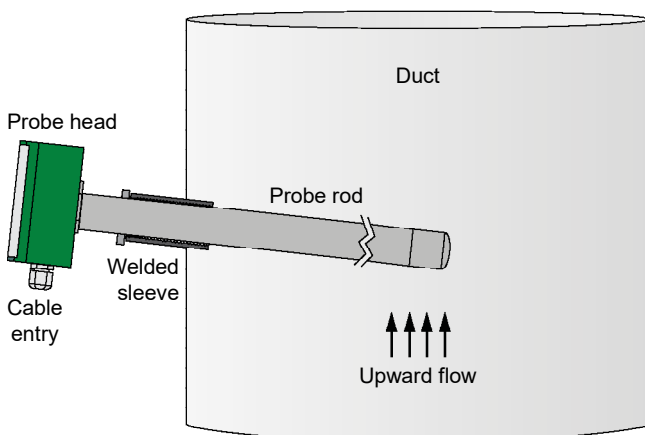

#### PRECONDITIONS ON SITE

- ambient temperature:  $-20...+55\text{ }^{\circ}\text{C}$
- ambient humidity: max. 90% (non-condensing)
- homogenous dust and stack gas distribution
- installation place with run-in/run-out zone of min. 5-fold length of duct diameter
- media temperature: max.  $250\text{ }^{\circ}\text{C}$  (optional: max.  $350\text{ }^{\circ}\text{C}$ )

## DESIGN AND FUNCTION

The OMD 14 consists of an in-situ probe and a probe head. The probe is equipped with a regulated sensor heating and electronics for operating and visualisation. In the probe head the evaluation electronics and the measuring value display are located.

Centrepiece of the device is a two-cell zirconium dioxide sensor. This measures the oxygen concentration by means of the amperometric measuring method. By the provision of the sensor with a higher reference voltage, a measurement of the water vapour content is additionally realised.

## DESIGN & DIMENSIONS

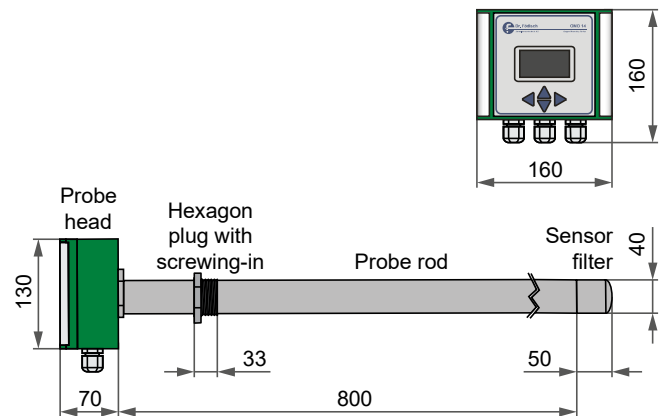

### TECHNICAL DATA

Housing:	compact device (integrated operating unit); IP65; 1 ½" fitting; approx. 160 mm x 160 mm x 930 mm (w x h x d); approx. 5.3 kg
Probe:	in-situ probe with zirconium dioxide sensor; probe rod length: 1000 mm (standard)
Measuring range:	<ul style="list-style-type: none"> <li>• O<sub>2</sub>: 0...25 vol. % (other measuring ranges on request), accuracy: ± 0.2 vol. %</li> <li>• H<sub>2</sub>O: 0...40 vol. %, accuracy: ± 2 vol. %</li> <li>• temperature (optional): 0...300 °C (standard)</li> </ul>
Response time:	T <sub>90</sub> < 60 s (dependent on application)
Ambient conditions:	-20...+55 °C; relative humidity: max. 90% (non-condensing)
Media temperature:	max. 250 °C (optional up to 350 °C)
Operational availability:	approx. 15 min (at 20 °C ambient temperature)
Manual calibration:	by optional adjustment device with test gas connection
Maintenance interval:	12 months (standard)
Display:	graphic display in text mode with momentary value display
Inputs:	For connection of one external device for calculation of additional measurands (e.g. temperature) the following inputs are existent: <ul style="list-style-type: none"> <li>• 1x analogue input (4...20 mA), potential-free</li> <li>• 1x digital input (status)</li> </ul>
Outputs:	<ul style="list-style-type: none"> <li>• 2x analogue output (4...20 mA), potential-free (1x oxygen concentration, 1x optional measurement of H<sub>2</sub>O or temperature)</li> <li>• 5x digital output (failure, maintenance, maintenance request, limit value 1 and 2), potential-free, max. switching capacity 25 W, rated voltage 60 V</li> </ul>
Interface:	RS485 (Modbus)
Process connection:	1 ½" welding sleeve
Power supply:	12-24 V DC or 100-240 V AC (depending on model); max. 25 W
Optional:	<ul style="list-style-type: none"> <li>• available sensors: PT100, thermocouple</li> <li>• media temperature up to 350 °C (measuring range: 0...400 °C)</li> </ul>
<i>Special models are possible on request.</i>	

## Multi gas analyser MGA 12 for O<sub>2</sub> measurement

Extractive gas analyser for continuous measurement of oxygen in flue gases and process gases



### APPLICATION

The multi gas analyser MGA 12 can be applied as single oxygen measuring device being rather independent from process condition.

For oxygen measurement two different measuring methods are applicable. These are carried out by electrochemical cell respectively by paramagnetic sensor.

#### POSSIBLE MEASURING RANGES

O <sub>2</sub> (E):	0...5 vol. %	0...25 vol. %	-
O <sub>2</sub> (P):	0...5 vol. %	0...25 vol. %	0...100 vol. %

*E = by measurement of electrochemical cell  
P = by measurement of paramagnetic sensor*

### YOUR BENEFITS AT A GLANCE

- limit value signalling and measuring range change-over
- two separated gas paths possible
- local diagnosis of the system state
- display of bar diagram
- flow control as well as display of flow rate
- control of a back-purging probe (interval and pulse time)
- control of zero point drift
- low maintenance requirement

### PRECONDITIONS ON SITE

- ambient temperature: 5...45 °C
- installation place indoors and dust-free
- protection against wetness
- protection against percussions/vibrations
- appropriate gas sampling and conditioning



## ELECTROCHEMICAL CELL

The electrochemical cell consists of a non-porous fluororesin membrane and a solid integrated gold electrode. By the reduction at the gold electrode, current is generated and converted to voltage by a thermistor. Thereby the measured voltage is proportional to the concentration of the measuring gas component.

## PARAMAGNETIC SENSOR

The measuring cell consists of a non-homogeneous magnetic field with a diamagnetic, nitrogen-filled glass bar-bell. Therein the paramagnetic oxygen molecules of the measuring gas react. By the therefrom motivated rotation of the glass bar-bell the emitted light of the light source is led via the mirror to the photo detector in the respective interval, whereupon the incoming light signal is proportional to the oxygen concentration in the measuring gas.

TECHNICAL DATA	
Housing:	robust housing with compact 19" format 3RU, IP40; 483 mm x 133 mm x 350 mm (w x h x d), approx. 5 kg
Measuring methods:	<ul style="list-style-type: none"> <li>• electrochemical cell</li> <li>• paramagnetic measuring method</li> </ul>
Electrochemical cell:	measuring range: 0...25 vol. %, further on request
Paramagnetic sensor:	<ul style="list-style-type: none"> <li>• measuring range: 0...5 vol. %, 0...25 vol. %, 0...100 vol. %, further on request</li> <li>• response time: <math>T_{90} &lt; 3</math> s with 1 l/min (150 ml/min, bypass) flow and gas change from nitrogen to air</li> <li>• repeatability: max. <math>\pm 0.03</math> % (time base for gas switch min. 5 min)</li> <li>• zero point drift: max. <math>\pm 0.1</math>% per week</li> <li>• influence at zero point: max. <math>\pm 0.05</math> per °C; no pressure influence</li> <li>• influence at span point: max. 0.2% of measured value per °C; backpressure regulator, no pressure influence</li> <li>• flow error: max. 0.1% with in-build fix bypass</li> <li>• position-dependent zero point deviation: max. 0.02 vol. % per 1° deviation from horizontal position</li> </ul>
Ambient conditions:	5...45 °C; relative humidity: max. 90% (non-condensing)
Sensitivity correction:	manual, with test gas (e.g. ambient air); optional: automatic
Display / Operating:	graphic display (LCD), 240 x 128 Pixel, background-lighted; menu-driven operating; display possibility in mg/m <sup>3</sup> , ppm and vol. %; languages (factory-set): German, English, French, Polish; membrane keyboard
Analogue outputs:	max. 5 active analogue outputs, 4...20 mA, potential-free, burden max. 500 Ohm
Digital inputs:	8 inputs (optocoupler; e.g. for sample probe, measuring gas pipe, gas cooling unit)
Digital outputs:	16 outputs, potential-free, 24 V DC with max. 0.4 A (max. 10 W); amongst others: <ul style="list-style-type: none"> <li>• output signals for failure, maintenance, maintenance request, limit values, measuring range change-over, Autocal</li> <li>• control of automatic probe back-purging</li> </ul>
Service interface RS232:	for remote software, compatible for all Windows operating systems (XP or higher version): <ul style="list-style-type: none"> <li>• visualisation of all data by intuitive user surface</li> <li>• data storage on PC in TXT format</li> <li>• loading/saving of all relevant configuration data</li> </ul>
Power supply:	110 V AC, 230 V AC / 50-60 Hz, 10 W (electrochemical cell) / 20 W (paramagnetic sensor)
Other functions:	<ul style="list-style-type: none"> <li>• standard: automatic zero point correction</li> <li>• optional: two separated gas paths; internal pump; analyser-specific PC user software for visualisation, (remote) control and recording of data via RS232 interface</li> </ul>
<i>Special models are possible on request.</i>	

## Multi gas analyser MGA 12 EX for O<sub>2</sub> measurement

Extractive gas analyser for continuous measurement of oxygen in potentially explosive atmospheres



- approved for Ex II 2G Ex db IIB+H2 T5 Gb
- protective principle Ex d
- explosive gases can be passed through in a closed loop



### APPLICATION

The multi gas analyser MGA 12 EX can be applied as single oxygen measuring device in potentially explosive atmospheres.

For oxygen measurement two different measuring methods are applicable. These are carried out by electrochemical cell respectively by paramagnetic sensor.

POSSIBLE MEASURING RANGES			
O <sub>2</sub> (E):	0...5 vol. %	0...25 vol. %	-
O <sub>2</sub> (P):	0...5 vol. %	0...25 vol. %	0...100 vol. %
<i>E = by measurement of electrochemical cell</i>			
<i>P = by measurement of paramagnetic sensor</i>			

### YOUR BENEFITS AT A GLANCE

- protective principle Ex d
- pressure-resistant gas path up to 3 bar
- explosive gases can be passed through in a closed loop
- integrated zero gas valve for zero point correction
- all gas-contacting elements are made of metal

### PRECONDITIONS ON SITE

- ambient temperature: -20...+40 °C
- protection against percussions/vibrations
- appropriate gas sampling and conditioning

## ELECTROCHEMICAL CELL

The electrochemical cell consists of a non-porous fluororesin membrane and a solid integrated gold electrode. By the reduction at the gold electrode, current is generated and converted to voltage by a thermistor. Thereby the measured voltage is proportional to the concentration of the measuring gas component.

## PARAMAGNETIC SENSOR

The measuring cell consists of a non-homogeneous magnetic field with a diamagnetic, nitrogen-filled glass bar-bell. Therein the paramagnetic oxygen molecules of the measuring gas react. By the therefrom motivated rotation of the glass bar-bell the emitted light of the light source is led via the mirror to the photo detector in the respective interval, whereupon the incoming light signal is proportional to the oxygen concentration in the measuring gas.

### TECHNICAL DATA

Housing:	robust housing, IP66; 315 mm x 415 mm x 178 mm (w x h x d); approx. 24 kg
Measuring methods:	<ul style="list-style-type: none"> <li>• electrochemical cell</li> <li>• paramagnetic measuring method</li> </ul>
Electrochemical cell:	measuring range: 0...25 vol. %
Paramagnetic sensor:	<ul style="list-style-type: none"> <li>• measuring range: 0...5 vol. %, 0...25 vol. %, 0...100 vol. %, further on request</li> <li>• response time: <math>T_{90} &lt; 3</math> s with 1 l/min (150 ml/min, bypass) flow and gas change from nitrogen to air</li> <li>• repeatability: max. <math>\pm 0.03</math> % (time base for gas switch min. 5 min)</li> <li>• zero point drift: max. <math>\pm 0.1</math>% per week</li> <li>• influence at zero point: max. <math>\pm 0.05</math> per °C; no pressure influence</li> <li>• influence at span point: max. 0.2% of measured value per °C; backpressure regulator, no pressure influence</li> <li>• flow error: max. 0.1% with in-build fix bypass</li> <li>• position-dependent zero point deviation: max. 0.02 vol. % per 1° deviation from horizontal position</li> </ul>
Ambient conditions:	-20...+40 °C; relative humidity: max. 90% (non-condensing)
Zero point correction:	automatic by integrated zero gas valve
Sensitivity correction:	manual, with test gas (e.g. ambient air)
Air pressure correction:	internal pressure sensor for real-time pressure compensation of measuring values
Gas inputs/outputs:	measuring gas input, zero gas input, exhaust output, air breather; respectively with flame barrier, 6 mm Swagelok
Display / Operating:	graphic display (LCD), 240 x 128 Pixel, background-lighted; menu-driven operating; display possibility in mg/m <sup>3</sup> , ppm and vol. %; languages (factory-set): German, English, French, Polish; 6 operating keys
Analogue outputs:	4 active analogue outputs, 4...20 mA, potential-free, burden max. 500 Ohm
Digital outputs:	4 digital outputs, potential-free, 24 V DC with max. 0.4 A (max. 10 W) for failure, maintenance, maintenance request and zero point setting
Service interface:	RS232 and remote software for maintenance and diagnostic purpose
Power supply:	230 V AC / 50-60 Hz, 40 W (max. 90 W)
<i>Special models are possible on request.</i>	

## Multi gas analyser MGA 20

Cold gas analyser for measurement of pollutants in flue gas and for process control using IR-technology



• QAL1 certification according  
DIN EN 15267-1 (2009),  
DIN EN 15267-2 (2009),  
DIN EN 15267-3 (2008)  
In progress



### FUNCTION

A high-precision infrared photometer is used to determine the concentration of up to 8 gas components by means of infrared absorption.

Furthermore an electrochemical cell, zirconium dioxide sensors or paramagnetic sensor can be configured for oxygen measurement.

The analyser MGA 20 includes a high precision optical bench (infrared photometer) consisting mainly of an IR light source with chopper wheel, a measuring cell, a motordriven filter wheel and a detector.

MEASURING RANGES *		
	Meas. range 1	Meas. range 2
CO:	0...75 mg/m <sup>3</sup>	0...5,000 mg/m <sup>3</sup>
CO <sub>2</sub> :	0...25 vol. %	0...50 vol. %
NO:	0...50 mg/m <sup>3</sup>	0...3,000 mg/m <sup>3</sup>
NO <sub>2</sub> :	0...50 mg/m <sup>3</sup>	0...1,000 mg/m <sup>3</sup>
N <sub>2</sub> O:	0...50 mg/m <sup>3</sup>	0...2,000 mg/m <sup>3</sup>
NO <sub>x</sub>	0...80 mg/m <sup>3</sup>	0...3,000 mg/m <sup>3</sup>
SO <sub>2</sub> :	0...45 mg/m <sup>3</sup>	0...2,000 mg/m <sup>3</sup>
CH <sub>4</sub> :	0...50 mg/m <sup>3</sup>	0...1,500 mg/m <sup>3</sup>
O <sub>2</sub> :	0...25 vol. %	-
* suitability test in progress		

### YOUR BENEFITS AT A GLANCE

- 7" touch colour display and an app-based menu
- automatic zero point setting by means of ambient air; no need of compressed air
- Filtercal technology for reference point adjustment; without gas consumption
- high sensitivity due to optical path length
- remote access
- internal pump (external pump on request)

### PRECONDITIONS ON SITE

- ambient temperature: 5...40 °C (with air conditioner 5...45°C)
- installation place indoors and dust-free
- protection against wetness
- protection against percussions/vibrations

## CEMS USING MGA 20



## OPTICAL BENCH

- includes a broadband infrared (IR) emitter with chopper wheel, measuring cell with zirconium oxide probe, detector unit with pyroelectric broadband detector and filter wheel, preamplifier and evaluation electronics
- constantly temperature regulated at 60 °C
- length of measuring path with direction changes: 7,200 mm
- spectral range: 2 µm to 12 µm

## TECHNICAL DATA

Analyser:	robust housing with compact 19" format 3 RU, IP40; 483 mm x 133 mm x 350 mm (w x h x d)
Measuring methods:	<ul style="list-style-type: none"> <li>• bi-frequency measuring method (NO<sub>2</sub>, SO<sub>2</sub>, CO<sub>2</sub>)</li> <li>• gas filter correlation (CO, NO, N<sub>2</sub>O, CH<sub>4</sub>)</li> <li>• zirconium dioxide sensor (O<sub>2</sub>)</li> <li>• electrochemical cell (optional for O<sub>2</sub>)</li> <li>• paramagnetic measuring method (optional for O<sub>2</sub>)</li> </ul>
Accuracy:	< 2% of the respective measuring range
Sensitivity correction:	manual, with test gas; optional: automatic
Response time:	T <sub>90</sub> < 180 s (depending on plant and chosen component)
Ambient conditions:	5...40 °C; relative humidity: max. 90% (non-condensing)
Display / Operating:	7" capacitive touch color display, with intuitive menu navigation display possibility in mg/m <sup>3</sup> , ppm and vol. %; languages (factory-set): German, English, French, Chinese
Analogue outputs:	8 active analogue outputs, 4...20 mA, potential-free, burden max. 500 Ohm
Digital inputs:	14 inputs (optocoupler; e.g. for error signal, sample probe, measuring gas pipe, gas cooling unit)
Digital outputs:	16 outputs, potential-free, 24 V DC with max. 0.4 A (max. 10 W); amongst others: <ul style="list-style-type: none"> <li>• output signals for failure, maintenance, maintenance request, limit values, measuring range change-over, Autocal</li> <li>• control of automatic probe back-purging</li> <li>• control of metering</li> <li>• control cabinet air conditioning and cabinet fan</li> </ul>
Interfaces:	<ul style="list-style-type: none"> <li>• RS232 (Modbus)</li> <li>• RJ45 (Remote access Ethernet/VNC), RJ45 (Modbus TCP/IP), RJ45 (Service Interface)</li> <li>• USB Typ A (USB Stick data exchange), USB Typ B (Service Interface)</li> </ul>
Power supply:	110...230 V AC / 50-60 Hz, 250 W
Other functions:	<ul style="list-style-type: none"> <li>• standard: temperature regulated infrared photometer; automatic zero point correction with ambient air</li> <li>• data logging function</li> <li>• visualization using the display, extensive visualization possibilities and diagnostic options</li> </ul>

# Flow measurement



The continuous velocity and temperature measurement is very important when operating a system with gas flows (for example indoor exhaust air, exhaust gases).

The flow rates are required for standardisation of pollutants' concentrations for the purpose of emission monitoring. For conversion into absolute emitted masses one needs the volume, which is calculated on the gas velocity. This also plays an important role in emissions allowance trading.

Flow measuring devices are mainly applied in:

- coal/gas/oil-fired power plants
- biomass power plants
- energy-from-waste plants
- incinerators
- chemical industry
- fertilizer industry

## Device installation at the duct

*(Recommendation  
of Dr. Födisch  
Umweltmesstechnik AG)*

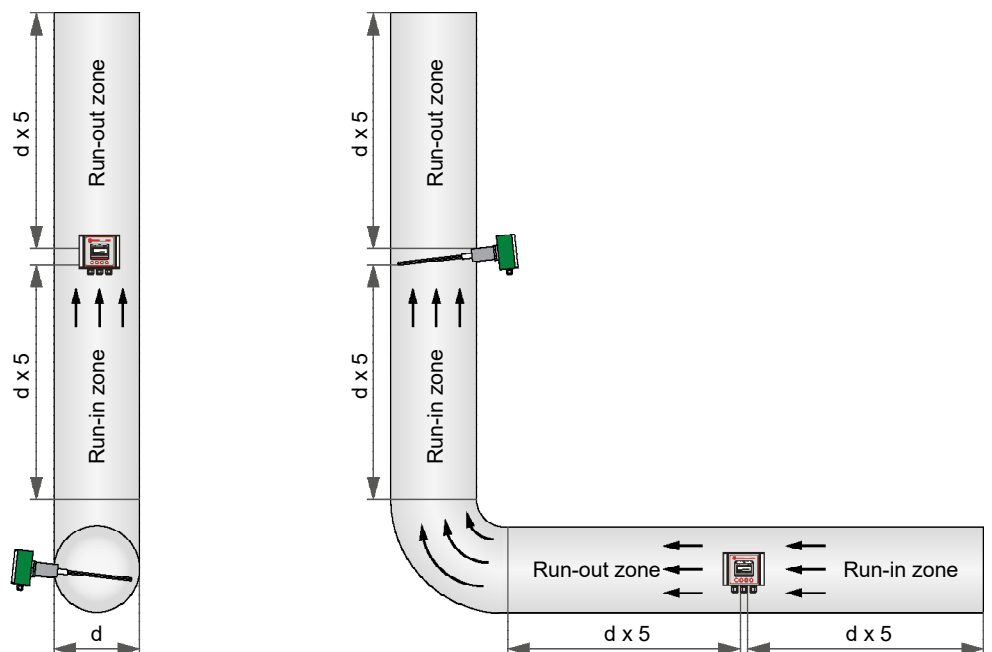



## Flow measuring devices by comparison

	FMD 02	FMD 09
<b>Field of application</b>		
Process monitoring of exhaust volume flow resp. of exhaust velocity	●	●
Application in heavily polluted gases with high dust content in the exhaust (> 50 mg/m <sup>3</sup> )		●
TUV-approved monitoring of exhaust volume flow resp. of exhaust velocity		● <sup>[1]</sup>
Exhaust conditions:		
• Dry gases	●	●
• Wet gases		●
• Corrosive gases		●
• Media temperature up to 280 °C	●	●
• Media temperature up to 800 °C		●
• Ambient temperature down to -20 °C		●
<b>Device characteristics</b>		
Measuring principle:		
• Dynamic pressure measurement	●	●
Measuring arrangement:		
• In-situ	●	●
• Extractive		
Probe material:		
• 1.4571	●	●
• Hastelloy		●
• Inconel		●
Data transfer:		
• Analogue outputs 4...20 mA	●	●
• Digital outputs (e.g. limit value 1/2, maintenance request, maintenance, failure)	●	●
Other device features:		
• Compact device with integrated electronics	●	
• Integrated display/operating unit	●	●
• Variable length of probe rod	●	●
• Back-purging		●
<b>Measuring components</b>		
Volume flow / velocity	●	●
Temperature	●	●
Absolute pressure		●
<sup>[1]</sup> suitability tested according to EN 15267-3, certified in compliance with QAL1 and MCERTS Performance Standards		

## Flow measuring device FMD 02

Continuous in-situ measurement of velocity and temperature of gas flows in pipelines



### APPLICATION

The use of the measuring principle of dynamic pressure and PT100 assures a device which is easy in design and operating as well as the realtime monitoring of the measuring parameters.

The operating and display unit is integrated in the probe head. On the high-quality display all measuring values, status information and parameters are displayed.

### INSTALLATION EXAMPLE

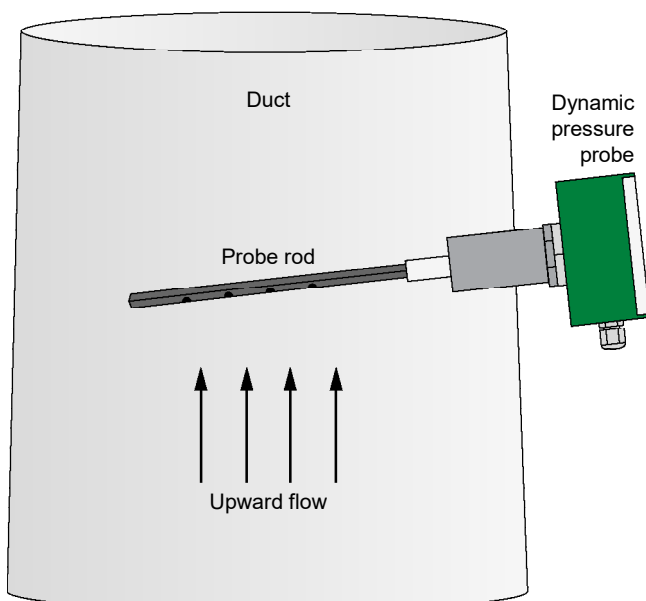

### YOUR BENEFITS AT A GLANCE

- compact device consisting of probe and operating unit → no separate operating device necessary
- local diagnosis of system state by integrated graphic display
- real-time display with line diagram
- readout of volume flow at standard reference conditions possible
- easy mounting
- very low maintenance requirement

### PRECONDITIONS ON SITE

- ambient temperature: -20...+50 °C
- location free of percussion
- homogenous dust and stack gas distribution
- flow velocity of min. 3 m/s
- dew-point spread: min. +5 K
- installation place with run-in/run-out zone of min. 5-fold/2-fold length of duct diameter

OPERATING UNIT

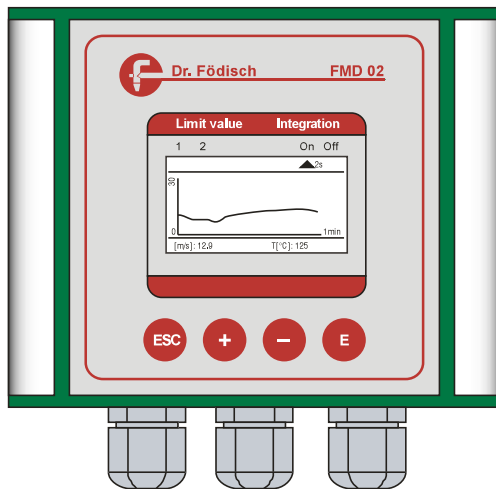

FUNCTION

The continuous measurement of velocity and temperature of gas flows is very important in the operation of a system with flowing gases (e.g. hall outlet air, exhaust etc.).

By the dynamic pressure probe the measuring gas is measured in the exhaust flow. Thereby the differential pressure is continuously measured. The signal which results from the differential pressure is a degree for the velocity of the exhaust. The microcontroller integrated in the device generates a proportional signal and evaluates the volume flow.

TECHNICAL DATA

Housing:	compact device (integrated operating unit); IP65, protection class 1
Dimensions:	approx. 160 mm x 160 mm x 655 mm (w x h x d) (standard)
Weight:	approx. 2.5 kg
Probe:	dynamic pressure probe with integrated PT100; immersion depth: 500 mm (standard)
Display / Operating:	graphic display (128 x 64 Pixel), 4 operating keys
Ambient temperature:	-20...+50 °C
Relative humidity:	no special sensitivity respective to atmospheric humidity
Dew-point spread:	min. +5 K
Media temperature:	max. 280 °C (higher temperatures on request)
Flow velocity:	from approx. 3 m/s
Measuring ranges:	<ul style="list-style-type: none"> <li>• velocity: 0...40 m/s</li> <li>• volume flow: 0...1.000.000 m<sup>3</sup>/h</li> <li>• differential pressure: 0...10 mbar (standard)</li> <li>• temperature: 0...300 °C</li> </ul>
Operational availability:	after approx. 5-15 min
Analogue outputs:	2x 4...20 mA; selection of following measurands: velocity, volume flow, differential pressure, temperature and optionally absolute pressure; burden: max. 500 Ω
Digital outputs:	status signals max. 24 V DC at 0.1 A: failure (normally closed, at failure open), limit value 1 and 2 (opening or closing contact selectable); load capacity: max. 60 Vp, max. 75 mA; forward resistance: max. 10 Ω
Process connection:	1" welding sleeve
Cable gland / tightening zone:	3x M20 x 1.5 / 9...13 mm
Power supply:	110/230 V AC, 50-60 Hz, 24 V DC, 5W
<i>Special models are possible on request.</i>	

## Flow measuring device FMD 09

Continuous in-situ measurement of velocity, temperature and absolute pressure of gas flows in pipelines

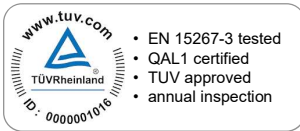

### APPLICATION

The use of the measuring principle of dynamic pressure and PT100 assures a device which is easy in design and operating as well as the realtime monitoring of the measuring parameters.

The operating and display unit is integrated in the weather protection casing. On the high-quality display all measuring values, status information and parameters are displayed.

Optionally, the absolute pressure at the measuring point can be measured continuously by an absolute pressure transmitter.

### INSTALLATION EXAMPLE

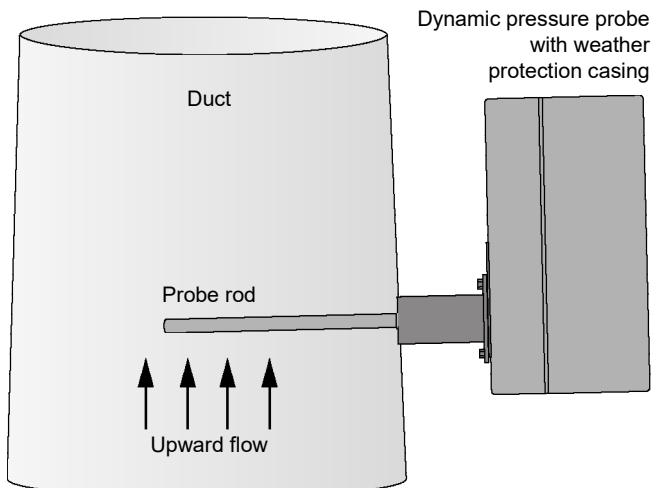

### YOUR BENEFITS AT A GLANCE

- compact device consisting of probe and operating unit → no separate operating device necessary
- local diagnosis of system state by integrated graphic display
- real-time display with line diagram
- readout of volume flow at standard reference conditions possible
- easy mounting
- very low maintenance requirement
- absolute pressure measurement (optional)

### PRECONDITIONS ON SITE

- ambient temperature: -20...+50 °C
- location free of percussion
- homogenous dust and stack gas distribution
- flow velocity of min. 3 m/s
- installation place with run-in/run-out zone of min. 5-fold/2-fold length of duct diameter

DESIGN & DIMENSIONS

Operation unit (inside the robe head)

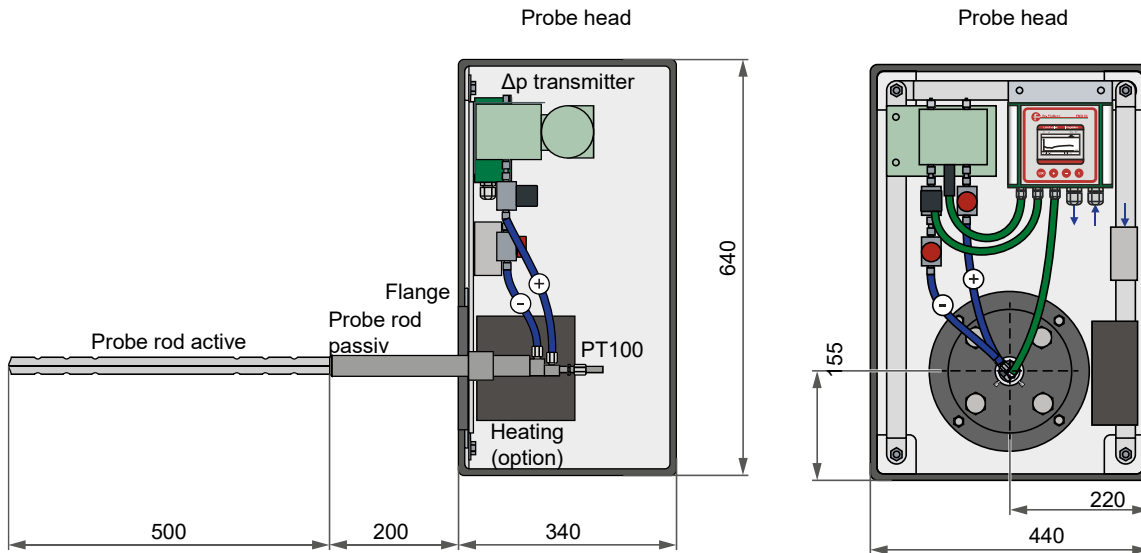
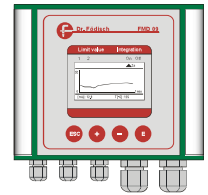

TECHNICAL DATA

Housing:	probe with GRP weather protection casing, IP55; 440 mm x 640 mm x 1040 mm (w x h x d), approx. 30 kg
Probe:	dynamic pressure probe with integrated PT100; immersion depth: 500 mm (standard)
Display / Operating:	integrated operating unit with graphic display and 4 operating keys
Ambient temperature:	-20...+50 °C
Relative humidity:	no special sensitivity respective to atmospheric humidity
Media temperature:	max. 280 °C (higher temperatures on request)
Flow velocity:	from approx. 3 m/s
Measuring ranges:	<ul style="list-style-type: none"> <li>• velocity: 0...30 m/s (0...60 m/s)</li> <li>• volume flow (in operation / in standard condition dry): 0...3.200.000 m<sup>3</sup>/h</li> <li>• differential pressure: 0...5 mbar (0...10 mbar), measurement uncertainty &lt;1%</li> <li>• temperature: 0...300 °C (0...800 °C), measurement uncertainty &lt;1%</li> <li>• absolute pressure (optional): 800...1200 mbar</li> </ul>
Operational availability:	after approx. 1 min
Analogue outputs:	3 x 4...20 mA; selection of the following measurands: velocity, volume flow (in operation / in standard condition dry), differential pressure, temperature and optionally absolute pressure; burden: max. 500 Ω
Digital outputs:	status signals: max. 24 V DC at 0.1 A; failure, maintenance, limit value 1 and 2
Process connection:	flange DN 80 PN 6
Power supply:	110/230 V AC, 50-60 Hz, 24 V DC, 5W
Optional:	<ul style="list-style-type: none"> <li>• readout of absolute pressure (measuring range: 800...1200 mbar)</li> <li>• feeding of frost protection heating (230 V AC, 500 W)</li> <li>• manual or automatic back-purging</li> </ul>
<i>Special models are possible on request.</i>	

# System accessories



In order to complete the portfolio it is possible to purchase system-relevant components. That allows system integration companies to assemble systems

locally while keeping the compliance with QAL 1 certification at the same time.

## System scheme of analyser system

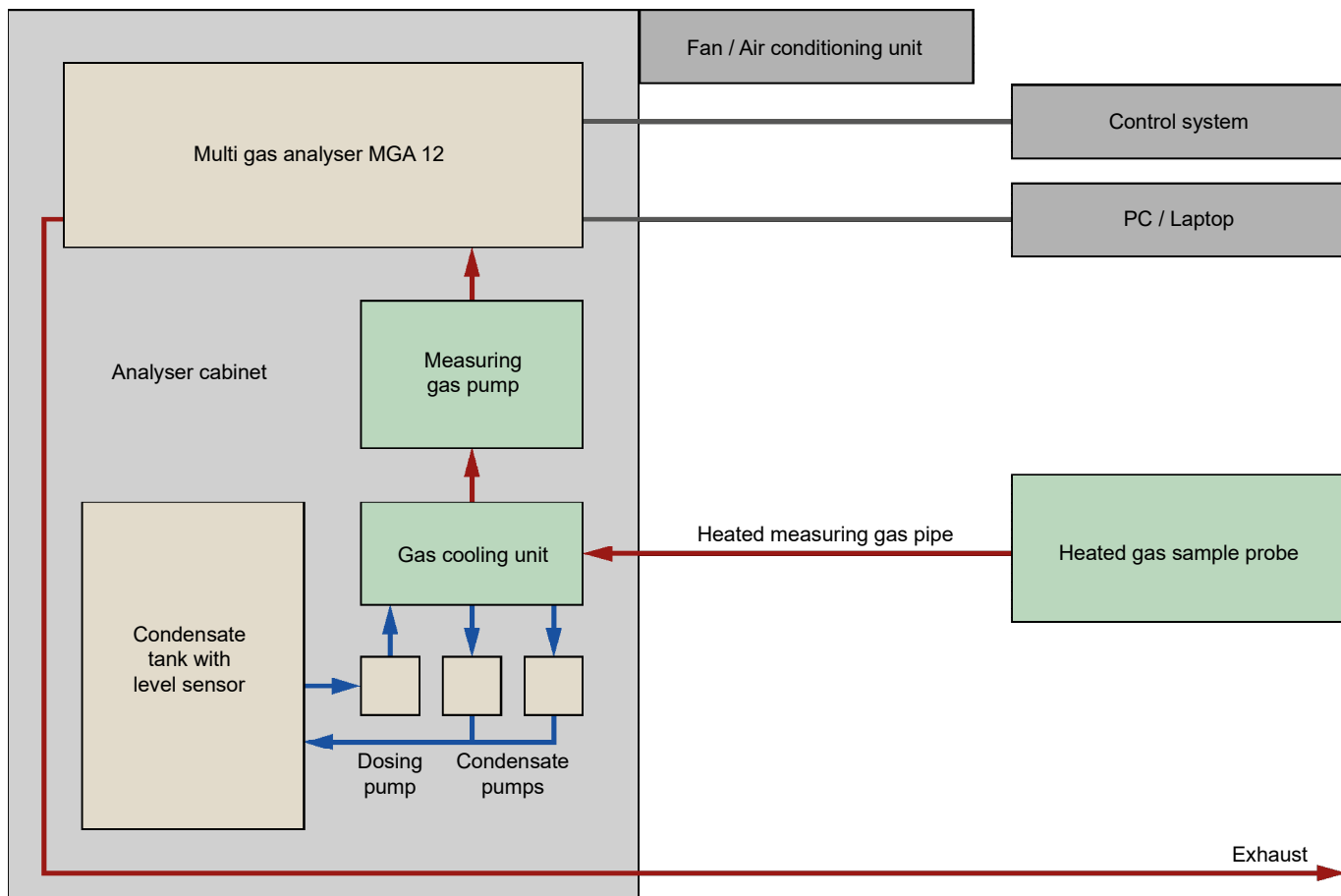



## Monitoring and control in gas analysis systems

(based on the example of MGA 12 system)

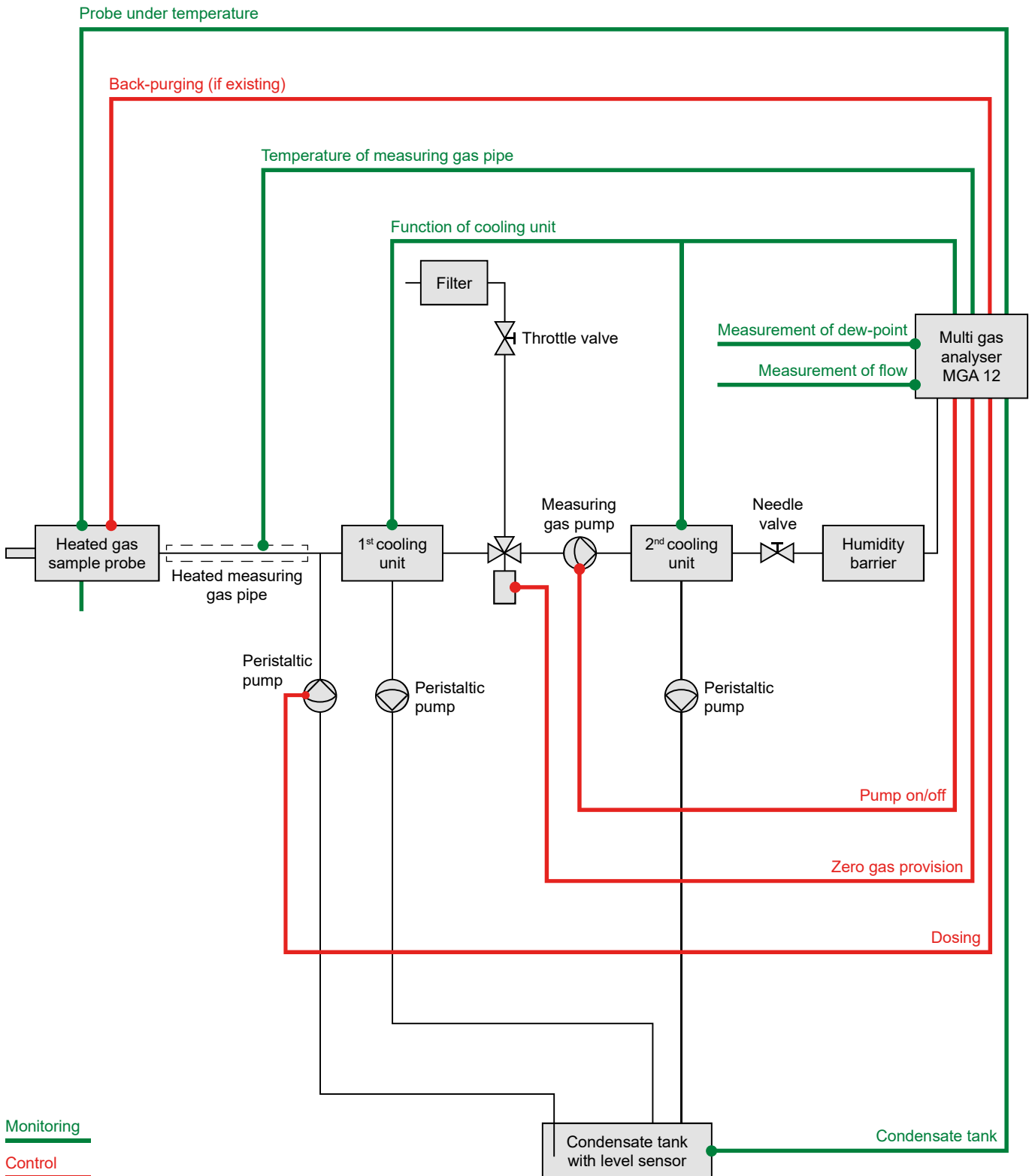

## Heated sample probe HSP 12

Extractive gas sampling in cold gas measuring systems for continuous emission measurement



### YOUR BENEFITS AT A GLANCE

- self-regulating
- under temperature alarm
- low maintenance costs
- applicable for integration in gas measuring systems of MGA 12

### PRECONDITIONS ON SITE

- ambient temperature: -20...+80 °C
- probe tube (optionally available, standard 1000 mm)
- flange for installation
- cable tray

### TECHNICAL DATA

Housing:	probe with isolation and outlet filter, IP54
Dimensions:	approx. 225 mm x 280 mm x 300 mm (w x h x d)
Weight:	approx. 15 kg
Material:	<ul style="list-style-type: none"> <li>• probe: 1.4571</li> <li>• sealing: Graphit/1.4404</li> </ul>
Filter material:	<ul style="list-style-type: none"> <li>• ceramics, filter fineness: 3 µm</li> <li>• stainless steel, filter fineness: 5 µm</li> </ul>
Ambient temperature:	-20...+80 °C
Exhaust temperature:	max. 600 °C
Dust loading:	max. 2 g/m <sup>3</sup>
Operating pressure:	max. 6 bar
Probe temperature:	max. 200 °C, self-regulating by heating elements
Under temperature alarm:	contact open at < 140 °C
Connections:	<ul style="list-style-type: none"> <li>• process connection: flange DN 65 PN 6</li> <li>• measuring gas: NPT 1/4"</li> <li>• test gas: tube Ø 6 mm</li> </ul>
Power supply:	115/230 V, 50/60 Hz, 500 VA
<i>Special models are possible on request.</i>	

## Optional back-purging

### FUNCTIONAL SCHEME

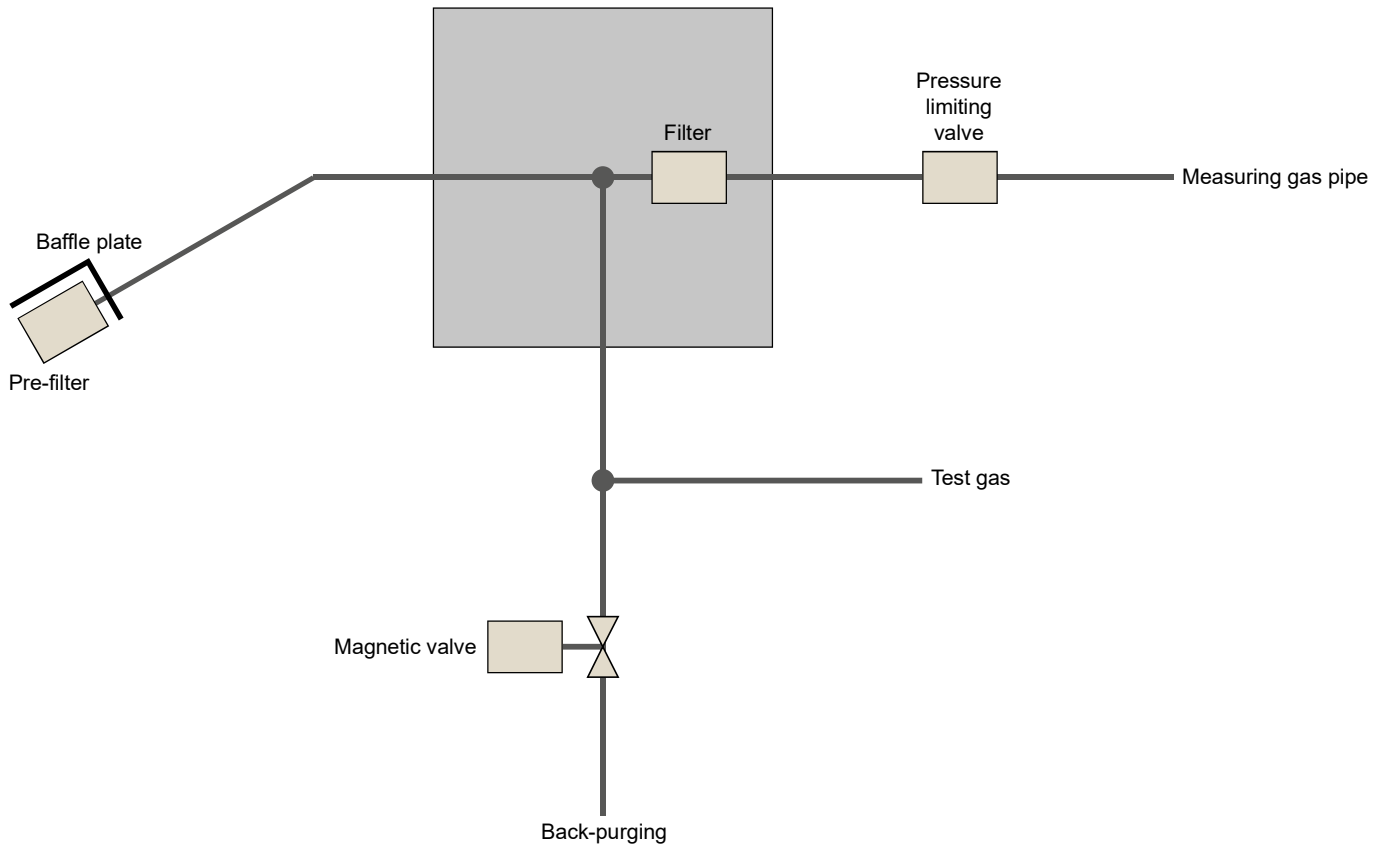

### TECHNICAL DATA OF PROBE BACK-PURGING

Connections:	<ul style="list-style-type: none"> <li>• process connection: flange DN 65 PN 6</li> <li>• measuring gas: DN 4/6</li> <li>• test gas: DN 4/6</li> <li>• back-purging: DN 6/8</li> </ul>
Back-purging pressure:	max. 6 bar
Differential pressure at test gas:	min. 100 mbar (overflow method)
Pressure limiting valve:	max. 1.2 bar
Pre-filter:	filter fineness: 5 µm, differential pressure: 13 mbar
Power supply:	24 V / 8 W for magnetic valve
Accessories:	<ul style="list-style-type: none"> <li>• pressure limiting valve (ETLA 666)</li> <li>• magnetic valve (ETLD 608)</li> <li>• pre-filter (ETLA 968)</li> <li>• baffle plate (ETLA 969)</li> </ul>

*Special models are possible on request.*

## Measuring gas pump MGP 12

Gas conveyance in cold gas measuring systems for continuous emission measurement



### YOUR BENEFITS AT A GLANCE

- bellows pump in compact design
- applicable in heavily polluted ambience
- pre-assembled → easy mounting
- low-noise operation
- low maintenance costs
- applicable for integration in gas measuring system of MGA 12

### PRECONDITIONS ON SITE

- ambient temperature: 0...50 °C
- installation in closed housings
- protection against touching of energised or moving elements
- protection against wetness and pollution
- protection against percussions/vibrations

### TECHNICAL DATA

Housing:	bellow pump with motor and integrated fan, IP20
Dimensions:	approx. 65 mm x 120 mm x 130 mm (w x h x d)
Weight:	approx. 1.3 kg
Media-touching materials:	PTFE, PCDC, 1.4571, 1.4401
Ambient conditions:	0...50 °C; max. 1000 m a.s.l.
Media temperature:	70 °C
Nominal flow rate:	280 l/h
Admission pressure:	max. 0.3 bar
Gas connections:	G 1/4"
Power supply:	115/230 V ± 5%, 50/60 Hz ± 2%, 100 W
<i>Special models are possible on request.</i>	

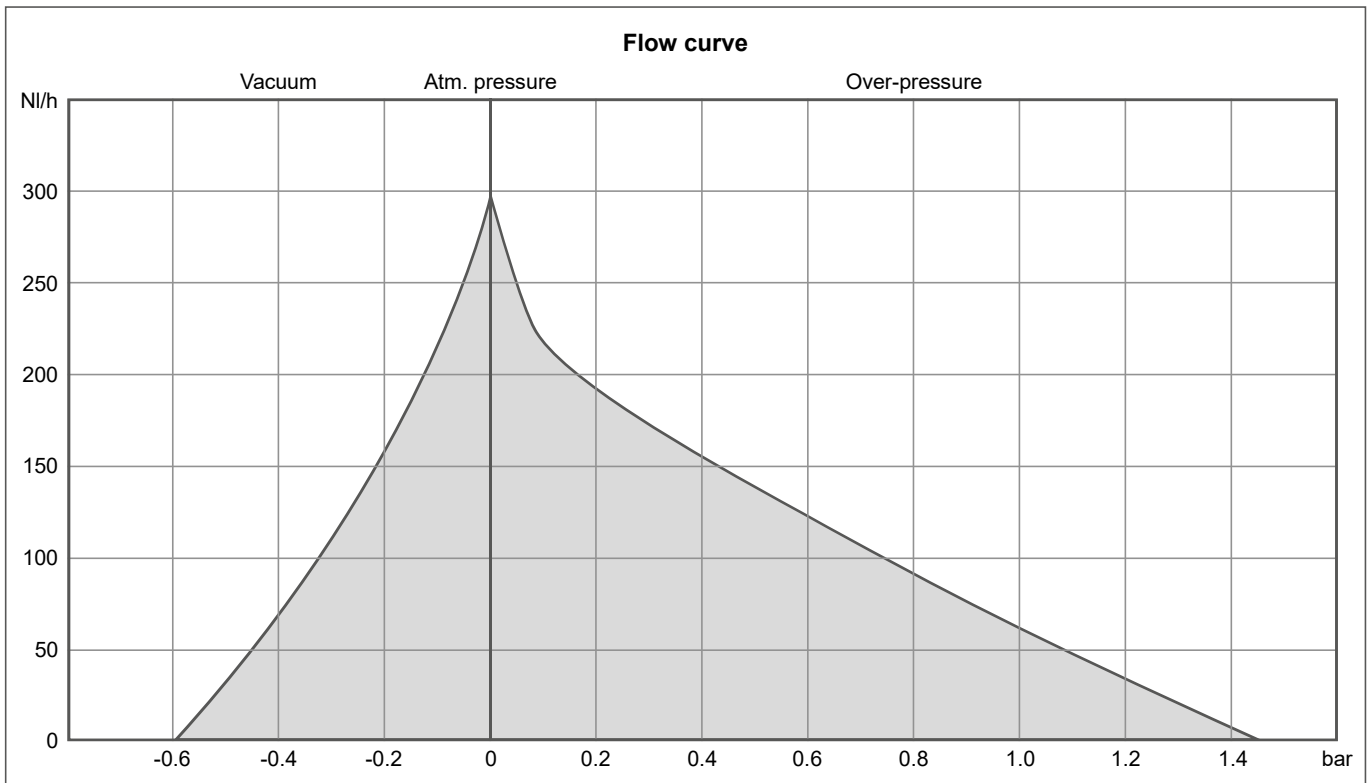

## Peltier gas cooling unit GCU 16

Cooling unit for conditioning of measuring gas in gas analysis systems for protection of subsequent analysis device



### APPLICATION

Safe process management depends on the prompt and precise determination of the respective operating parameters. Hence the gas analysis is an important precondition for the safe and efficient control of process flows, for protection of the environment as well as for quality assurance.

Many analysis techniques require the extraction of the measuring gas. However, this results in process-related impurity by particles or moisture and influences measuring results. Therefore the sampled measuring gas must be conditioned by a gas cooling unit before entry into the analysis device. This is, for example, applied at the monitoring of flue gas emissions in power plants.

### OPERATING UNIT



### YOUR BENEFITS AT A GLANCE

- compact design
- decreasing of water content in the measuring gas to a constant, lower dew-point → precipitation of water
- designed for the requirements in automated measuring systems (AMS) acc. to EN 15267-3
- pre-assembled → easy mounting
- short commissioning time
- display of current cooling block temperature
- nominal value of cooling block temperature and alarm limits adjustable
- low-noise operation
- low maintenance costs

### PRECONDITIONS ON SITE

- ambient temperature: 5...50 °C
- gas inlet temperature max. 140 °C
- installation place indoors
- protection against wetness
- protection against percussions/vibrations



## FUNCTION

The control of the cooling unit is made by a microprocessor. For operating the device possesses a graphic display with five operating keys. As a main display the current cooling block temperature is shown. Via the menu, amongst others, its nominal value as well as the alarm limits for over-/undershooting the nominal value can be adjusted. Messages are signalled via the status LEDs and the graphic display as well as they are output via the alarm output.

In the gas analysis system the alarm output can be used for example for controlling a measuring gas pump to enable a switch-on of the measuring gas not before reaching the admissible cooling range. The GCU 16 is equipped with two heat exchangers (optionally made of glass or PVDF) which are factory-set considered by the control.

## TECHNICAL DATA

Housing:	stainless steel housing, IP20
Dimensions:	approx. 310 mm x 190 mm x 180 mm (w x h x d)
Weight:	approx. 7.5 kg
Display / Operating:	graphic display, 3 status LEDs, 5 operating keys; cooling block temperature as well as alarm limits adjustable via menu; temperature value output selectable in °C or °F
Cooling:	by Peltier effect; cooling power: 90 kJ/h at 25 °C ambient temperature
Ambient temperature:	operation: 5...50 °C; storage: -20 ... +60 °C
Dew-point stability:	0.1 K
Gas temperature:	inlet temperature: max. 140 °C ; outlet temperature: 2...20 °C (preset: 5 °C)
Flow rate:	max. 2 l/min (at 65 °C gas inlet temperature)
Differential pressure at 2 l/min:	19 mbar
Dead volume of heat exchanger:	glass: 19 ml (for each heat exchanger); PVDF: 18 ml (for each heat exchanger)
Pressure inside of heat exchanger:	glass: max. 3 bar; PVDF: max. 2 bar (max. permissible system operating pressure limited by possibly used peristaltic pumps and filters)
Connections of heat exchanger (metric):	glass: measuring gas inlet/outlet: GL14 (6 mm), condensate outlet: GL18 (8 mm); PVDF: measuring gas inlet/outlet: DN 4/6, condensate outlet: G1/4
Switching capacity of status contact:	potential-free output (alarm output), max. 250 V AC, 150 V DC, 2 A, 50 W
Power supply:	230 V AC / 50 Hz, max. 140 VA / 110 W
Electrical connections:	connector according to EN 175301-803 (power supply, alarm output)
Cable cross-section / tightening zone:	max. 1.5 mm <sup>2</sup> / 8...10 mm (adapted to rated current)
Mechanical load:	2...13.2 Hz, amplitude ± 1.0 mm, acceleration 13.2...100 Hz (tested according to DNVGL-CG-0339, table 6)
Optional:	<ul style="list-style-type: none"> <li>power supply 110 V AC, 60 Hz</li> <li>material of heat exchanger: glass or PVDF</li> </ul>
<i>Special models are possible on request.</i>	

## Display Unit DUx 20

Display unit for dust monitors and fine dust sensors

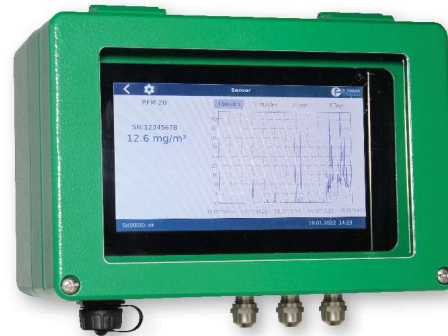

### APPLICATION

DUx 20 is an additional instrument for monitoring and operating of measurement devices. It is used for comfortable operation of up to four Modbus-based devices which are difficult to access. Dust monitors (PFM 20, PFM 20 F) and fine dust sensors (FDS 15, FDS 17) can be connected in series.

The robust enclosure integrates a 7" touch panel for input of operation parameters. Measured values are displayed as numerical values as well as time based measurement curves.

Values and device status can be stored via SD memory and transferred via USB flash.

### YOUR BENEFITS AT A GLANCE

- Suitable for industrial environment
- Several measuring devices can be managed with one unit at a well-suited location
- Monitoring of multiple measurements points and limits
- Intuitive menu navigation (German and English)
- Display of measured values in number format and in a diagram
- Storage of measured values and device status
- Data transfer via USB connection
- Easy software update via SD memory card

### DESIGN

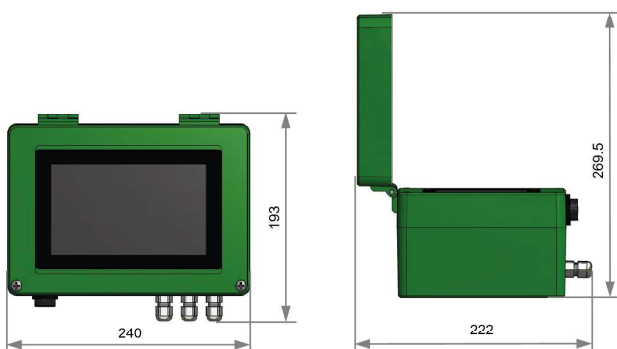

### USER INTERFACE (EXAMPLE FDS 17)

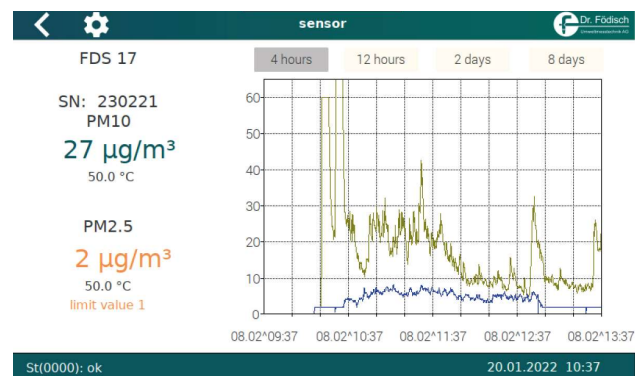

INSTALLATION EXAMPLE

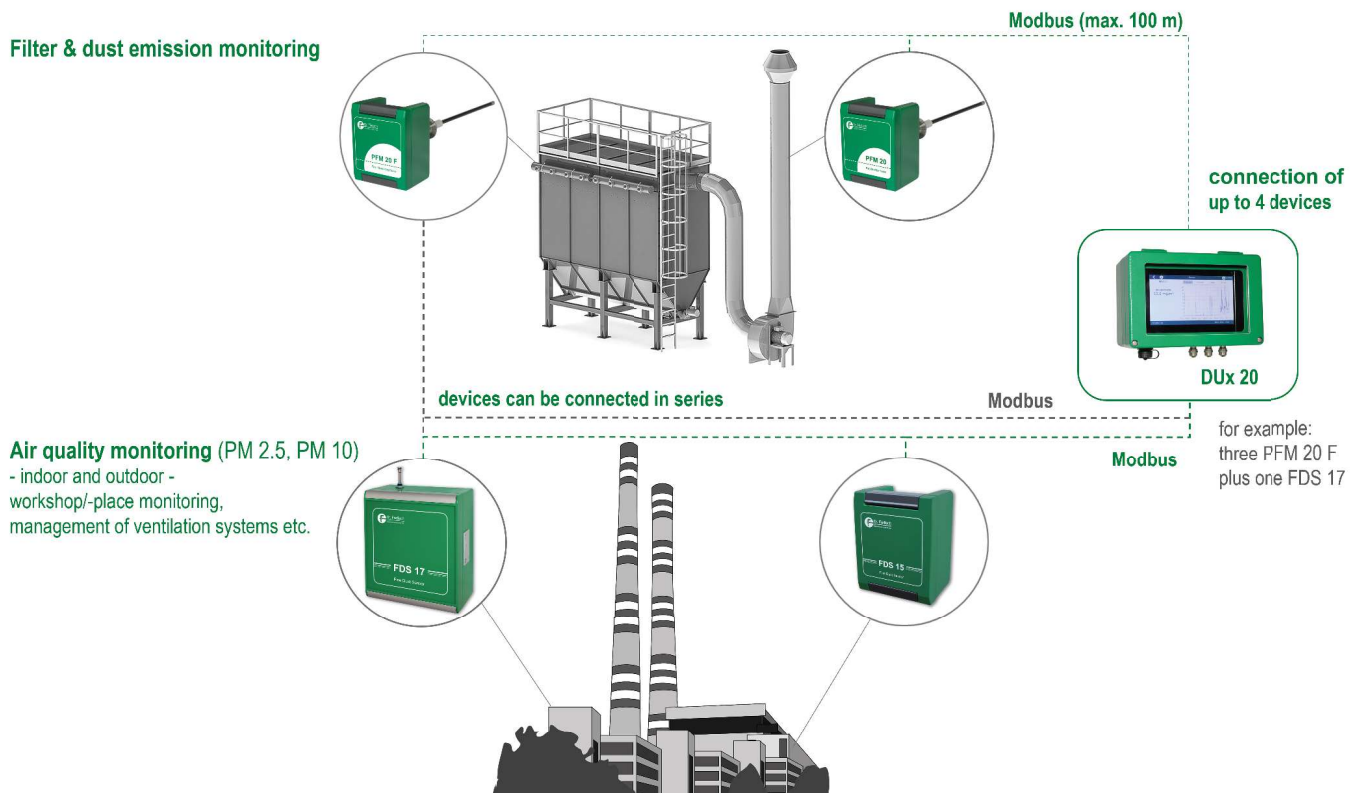

TECHNICAL DATA

Housing:	made of aluminium with integrated touch panel
Dimensions:	240 x 135 x 160 mm (w x h x d)
Weight:	approx. 3.5 kg
Protection degree:	IP 65
Display / Operating:	7"-touch panel, 800 x 480 pixel; Language selection: German, English
Data storage:	internal data logger with real-time clock for automatic storage of measuring values
Data storage capacity:	measuring values of >10 years
Interfaces:	RS485 (Modbus) USB A connection for data exchange and updating
Digital outputs:	2 potential-free contacts for limit value 1 and limit value 2; 24 V, 100 mA
Power supply:	100...240 V AC, 0.7 A, 50...60 Hz; pre-fuse min. 1 A optional 12...24 V DC, 2.1 A pre-fuse min. 1 A
Number of connectable measuring devices:	up to 4 measuring devices
<i>Special models are possible on request.</i>	











